

**phyCORE-AM3517**  
**System on Module and Carrier Board**  
**Hardware Manual**

**Document No:** L-761e\_1  
**Product No:** PCM-048/PCM-961  
**SOM PCB No:** 1335.1  
**CB PCB No:** 1336.1  
**Edition:** June 8, 2011

In this manual are descriptions for copyrighted products that are not explicitly indicated as such. The absence of the trademark (™) and copyright (©) symbols does not imply that a product is not protected. Additionally, registered patents and trademarks are similarly not expressly indicated in this manual.

The information in this document has been carefully checked and is believed to be entirely reliable. However, PHYTEC America LLC assumes no responsibility for any inaccuracies. PHYTEC America LLC neither gives any guarantee nor accepts any liability whatsoever for consequential damages resulting from the use of this manual or its associated product. PHYTEC America LLC reserves the right to alter the information contained herein without prior notification and accepts no responsibility for any damages which might result.

Additionally, PHYTEC America LLC offers no guarantee nor accepts any liability for damages arising from the improper usage or improper installation of the hardware or software. PHYTEC America LLC further reserves the right to alter the layout and/or design of the hardware without prior notification and accepts no liability for doing so.

© Copyright 2011 PHYTEC America LLC, Bainbridge Island, WA.

Rights - including those of translation, reprint, broadcast, photomechanical or similar reproduction and storage or processing in computer systems, in whole or in part - are reserved. No reproduction may occur without the express written consent from PHYTEC America LLC.

	<b>EUROPE</b>	<b>NORTH AMERICA</b>
<b>Address:</b>	PHYTEC Technologie Holding AG Robert-Koch-Str. 39 D-55129 Mainz GERMANY	PHYTEC America LLC 203 Parfitt Way SW, Suite G100 Bainbridge Island, WA 98110 USA
<b>Ordering Information:</b>	+49 (800) 0749832	1 (800) 278-9913
<b>Technical Support:</b>	+49 (6131) 9221-31	1 (800) 278-9913
<b>Fax:</b>	+49 (6131) 9221-33	1 (206) 780-9135
<b>Website:</b>	<a href="http://www.phytec.eu/europe">http://www.phytec.eu/europe</a>	<a href="http://www.phytec.com">http://www.phytec.com</a>

## Table of Contents

<b>List of Tables</b> .....	<b>iii</b>
<b>List of Figures</b> .....	<b>v</b>
<b>Conventions, Abbreviations, and Acronyms</b> .....	<b>vi</b>
<b>Preface</b> .....	<b>viii</b>
<b>Part I: PCM-048/phyCORE-AM3517 System on Module</b> .....	<b>1</b>
1 Introduction .....	2
1.1 Block Diagram .....	4
1.2 View of the phyCORE-AM3517 .....	5
2 Pin Description .....	7
3 Jumpers .....	19
3.1 Jumper Settings .....	22
4 Power .....	25
4.1 Primary System Power (VIN & VIN_3V3) .....	25
4.2 Secondary Battery Power (VBAT) .....	25
4.3 PMIC Supplies (U2) .....	25
4.4 RTC Supplies (U2) .....	26
4.5 Selecting Shunt Resistors for Current Measurements .....	26
4.6 Voltage Supervisor (U2, U21) .....	26
5 External RTC (U22) .....	28
6 System Configuration and Booting .....	29
6.1 Boot Process .....	32
7 System Memory .....	33
7.1 SDRAM (U8, U9) .....	33
7.2 NAND Flash (U16) .....	33
7.3 EEPROM (U13) .....	34
7.4 Memory Map .....	34
8 Serial Interfaces .....	35
8.1 RS-232 Transceiver (U15) .....	35
8.2 Ethernet PHY (U12) .....	35
8.3 USB OTG (U1) .....	35
8.4 USB1 Host (U1, U7) .....	36
9 Debug Interface (X1) .....	37
10 Touch Screen Controller (U25) .....	38
11 LCD LVDS Transmitter .....	39
11.1 LVDS and SOM I/O Voltage (J23) .....	40
12 General Purpose Memory Controller (U2) .....	41
13 AM3517 IO and GPMC Bus Voltage .....	42
14 Technical Specifications .....	43
15 Hints for Handling the phyCORE-AM3517 .....	45
<b>Part II: PCM-961/phyCORE-AM3517 Carrier Board</b> .....	<b>46</b>
16 Introduction .....	47
17 Overview of Peripherals .....	48
18 Jumpers .....	51
19 phyCORE-AM3517 SOM Connectivity .....	55
20 Power .....	56
20.1 Wall Adapter Input (X9) .....	56
20.2 Power over Ethernet (PoE) .....	57

---

20.3	Lithium-Ion Battery	58
20.4	3.3V Supply (U27)	58
20.5	1.8V Supply (U31)	58
20.6	Current Measurement	59
21	JTAG Connectivity	60
22	Audio Interface	62
23	Ethernet Connectivity	64
24	USB Connectivity	65
25	LCD and DVI Connectivity	67
25.1	DVI Connector	70
25.2	LVDS Connectors	70
25.3	TTL LCD Connector	71
26	GPIO Expansion Connector	72
27	RS-232 Connectivity	73
28	SD/SDIO/MMC Connectivity	77
29	CAN (Controller Area Network) Interface	79
30	Wireless Connector	80
31	TV Out	82
32	Camera Interface	83
33	User Buttons	85
34	User LEDs	87
35	Boot Mode Selection	88
36	System Reset Button	92
<b>Part III: PCM-988/GPIO Expansion Board</b>		<b>93</b>
37	Introduction	94
38	System Signal Mapping	96
39	GPMC Signal Mapping	97
40	UART Signal Mapping	99
41	I <sup>2</sup> C Signal Mapping	100
42	GPIO Signal Mapping	101
43	USB Signal Mapping	102
44	CAN Signal Mapping	103
45	Ethernet Signal Mapping	104
46	HDQ Signal Mapping	105
47	McBSP Signal Mapping	106
48	SPI Signal Mapping	107
49	Power Signal Mapping	108
<b>Revision History</b>		<b>109</b>

## List of Tables

<b>Conventions, Abbreviations, and Acronyms</b> .....	<b>vi</b>
Table i-1. Abbreviations and Acronyms Used in This Manual .....	vi
<b>Part I: PCM-048/phyCORE-AM3517 System on Module</b> .....	<b>1</b>
Table 2-1. Pin Descriptions, phyCORE-Connector X2, Row A .....	8
Table 2-2. Pin Descriptions, phyCORE-Connector X2, Row B .....	10
Table 2-3. Pin Descriptions, phyCORE-Connector X2, Row C .....	13
Table 2-4. Pin Descriptions, phyCORE-Connector X2, Row D .....	15
Table 3-1. Jumper Settings .....	22
Table 4-1. Current Measurements .....	26
Table 6-1. Peripheral Booting Configuration Pins after POR .....	29
Table 6-2. Booting Configuration Pins after a Warm Reset .....	30
Table 7-1. Valid SDRAM Memory Address Ranges .....	33
Table 7-2. LOCK Pin Jumper Settings .....	34
Table 7-3. phyCORE-AM3517 Memory Map .....	34
Table 8-1. UART3 TTL and RS-232 Level Signals .....	35
Table 8-2. Applicable USB Operating Mode Connectors .....	36
Table 12-1. GPMC Signal Mapping .....	41
Table 14-1. Technical Specifications .....	43
Table 14-2. Static Operating Characteristics .....	44
<b>Part II: PCM-961/phyCORE-AM3517 Carrier Board</b> .....	<b>46</b>
Table 17-1. Connectors and Headers .....	48
Table 17-2. Description of the Buttons and Switches .....	49
Table 17-3. Description of LEDs .....	49
Table 18-1. Jumper Settings .....	52
Table 20-1. Possible Ethernet PSE Options .....	57
Table 21-1. phyCORE-AM3517 JTAG Connector X13 Pin Descriptions .....	60
Table 21-2. Compatible JTAG Probes for the phyCORE-AM3517 Carrier Board .....	61
Table 25-1. 24-bit 8:8:8 mode (S1-1,S1-2, S1-3, S1-4 = O,O,O,O) .....	69
Table 25-2. 12-bit 4:4:4 mode (S1-1,S1-2, S1-3, S1-4 = C, C, C, O) .....	69
Table 25-3. 16-bit 5:6:5 mode (S1-1,S1-2, S1-3, S1-4 = C, C, O, C) .....	69
Table 25-4. 18-bit 6:6:6 mode (S1-1,S1-2, S1-3, S1-4 = C, C, O, O) .....	69
Table 25-5. LCD Mode Jumper Summary (S1-1,S1-2, S1-3, S1-4) .....	70
Table 27-1. Connector P1 (UART3) Pin Descriptions .....	74
Table 27-2. Connector X29 (UART2) Pin Descriptions .....	74
Table 27-3. TTL UART Pin Header (X10) Descriptions .....	75
Table 28-1. SDIO Easy Access Header Connector Signal Descriptions .....	78
Table 30-1. Wireless Connector (X7) Signal Descriptions .....	80
Table 32-1. Camera Interface (X4) Signal Descriptions .....	83
Table 35-1. Boot Selection Switches and Descriptions .....	89
Table 35-2. Boot Order Switch Configurations .....	89
<b>Part III: PCM-988/GPIO Expansion Board</b> .....	<b>93</b>
Table 37-1. GPIO Expansion Connector - Signals Removed .....	95
Table 38-1. System Signal Mapping .....	96
Table 39-1. GPMC Signal Mapping .....	97
Table 40-1. UART Signal Mapping .....	99
Table 41-1. I <sup>2</sup> C Signal Mapping .....	100
Table 42-1. GPIO Signal Mapping .....	101
Table 43-1. USB Signal Mapping .....	102

---

Table 44-1. CAN Signal Mapping .....	103
Table 45-1. Ethernet Signal Mapping .....	104
Table 46-1. HDQ Signal Mapping .....	105
Table 47-1. McBSP Signal Mapping .....	106
Table 48-1. SPI Signal Mapping .....	107
Table 49-1. Power Signal Mapping .....	108
<b>Revision History .....</b>	<b>109</b>
Table 50-1. Revision History .....	109

## List of Figures

<b>Part I: PCM-048/phyCORE-AM3517 System on Module</b> . . . . .	<b>1</b>
Fig. 1-1. phyCORE-AM3517 Block Diagram . . . . .	4
Fig. 1-2. Top View of the phyCORE-AM3517 (Controller Side) . . . . .	5
Fig. 1-3. Bottom View of the phyCORE-AM3517 (Connector Side) . . . . .	6
Fig. 2-1. Pin-out of the phyCORE-Connector (Top View, with Cross Section Insert) . . . . .	8
Fig. 3-1. Jumper Locations (Connector Side) . . . . .	19
Fig. 3-2. Jumper Locations (Controller Side) . . . . .	20
Fig. 3-3. Default Jumper Settings (Connector Side) . . . . .	21
Fig. 3-4. Default Jumper Settings (Controller Side) . . . . .	22
Fig. 9-1. JTAG Interface X1 (Controller Side) . . . . .	37
Fig. 11-1. LVDS Multiplexing Scheme <sup>1</sup> . . . . .	39
Fig. 14-1. phyCORE-AM3517 Physical Dimensions . . . . .	43
<b>Part II: PCM-961/phyCORE-AM3517 Carrier Board</b> . . . . .	<b>46</b>
Fig. 16-1. phyCORE-AM3517 Carrier Board . . . . .	47
Fig. 17-1. Overview of Peripherals . . . . .	48
Fig. 18-1. Jumper Locations and Default Settings . . . . .	51
Fig. 18-2. Typical Jumper Pad Numbering Scheme (Removable Jumpers) . . . . .	51
Fig. 19-1. phyCORE-AM3517 SOM Connectivity to the Carrier Board . . . . .	55
Fig. 20-1. Powering Scheme . . . . .	56
Fig. 21-1. JTAG Probe Connectivity to the phyCORE-AM3517 . . . . .	60
Fig. 22-1. Audio Interface Connectors and Jumpers . . . . .	62
Fig. 23-1. Ethernet Interface Connector and LEDs . . . . .	64
Fig. 24-1. USB Interface Connectors and Jumpers . . . . .	65
Fig. 25-1. LCD/DVI Interface Connectors, Jumpers, and Switches . . . . .	67
Fig. 25-2. LCD Signal Mapping in 24-bit Mode with a 24-bit LCD . . . . .	68
Fig. 25-3. LCD Signal Mapping in 16-bit Mode with an 16-Bit LCD . . . . .	68
Fig. 26-1. GPIO Expansion Connector . . . . .	72
Fig. 27-1. RS-232 Interface Connectors and Jumpers . . . . .	73
Fig. 27-2. DB9 RS-232 Connectors P1 (UART3) Pin Numbering . . . . .	73
Fig. 27-3. Connector X29 (UART2) Pin Numbering . . . . .	74
Fig. 27-4. UART3/UART2 Header Connector X10 Pin Numbering . . . . .	75
Fig. 28-1. SDIO Interface Connectors and Jumpers . . . . .	77
Fig. 29-1. CAN Interface Connectors and Jumpers . . . . .	79
Fig. 30-1. Wireless Interface Connector . . . . .	80
Fig. 31-1. TV Out Connector . . . . .	82
Fig. 32-1. Camera Interface Connectors and Jumpers . . . . .	83
Fig. 33-1. User Buttons and Jumpers . . . . .	85
Fig. 34-1. User LEDs and Jumpers . . . . .	87
Fig. 35-1. Boot Mode Selection Connectors and Jumpers . . . . .	88
Fig. 35-2. Boot Switches - Default Settings . . . . .	88
Fig. 36-1. System Reset Button . . . . .	92
<b>Part III: PCM-988/GPIO Expansion Board</b> . . . . .	<b>93</b>
Fig. 37-1. PCM-988/GPIO Expansion Board and Patch Field . . . . .	94

## Conventions, Abbreviations, and Acronyms

### Conventions

The conventions used in this manual are as follows:

- Signals that are preceded by a “/” character are designated as active low signals. Their active state is when they are driven low, or are driving low; for example: /RESET.
- Tables show the default setting or jumper position in **bold, teal text**.
- Text in [blue](#) indicates a hyperlink, either internal or external to the document. Click these links to quickly jump to the applicable URL, part, chapter, table, or figure.
- References made to the *phyCORE-Connector* always refer to the high density molex connectors on the underside of the phyCORE-AM3517 System on Module.

### Abbreviations and Acronyms

Many acronyms and abbreviations are used throughout this manual. Use the table below to navigate unfamiliar terms used in this document.

**Table i-1. Abbreviations and Acronyms Used in This Manual**

Abbreviation	Definition
BTN1	User button 1; used in reference to one of the four available user buttons on the Carrier Board
BTN2	User button 2; used in reference to one of the four available user buttons on the Carrier Board
BTN3	User button 3; used in reference to one of the four available user buttons on the Carrier Board
BTN4	User button 4; used in reference to one of the four available user buttons on the Carrier Board
CB	Carrier Board; used in reference to the PCM-961/phyCORE-AM3517 Carrier Board
CPLD	Complex Programmable Logic Device
EMI	Electromagnetic Interference
GPI	General purpose input
GPIO	General purpose input and output
GPIOEBPF	GPIO Expansion Board Patch Field; used in reference with the PCM-988/GPIO Expansion Board and its associated patch field
GPMC	General Purpose Memory Controller
GPO	General purpose output
J	Solder jumper; these types of jumpers require solder equipment to remove and place
JP	Solderless jumper; these types of jumpers can be removed and placed by hand with no special tools
PCB	Printed circuit board
PoE	Power over Ethernet
POT	Potentiometer
PMIC	Power Management Integrated Circuit
PSE	Power sourcing equipment; the device in a PoE network that provides power to connected devices - usually a switch, router, or stand alone power injector



**Table i-1. Abbreviations and Acronyms Used in This Manual**

<b>Abbreviation</b>	<b>Definition</b>
RTC	Real-time clock
SMT	Surface mount technology
SOM	System on Module; used in reference to the PCM-048/phyCORE-AM3517 System on Module
TRM	Technical Reference Manual
VBAT	SOM battery supply input
VFP	Vector Floating Point

---

## Preface

This phyCORE-AM3517 Hardware Manual describes the System on Module's design and functions. Precise specifications for the Texas Instruments AM3517 processor can be found in the processor datasheet and/or user's manual.

In this hardware manual and in the schematics, active low signals are denoted by a "/" preceding the signal name, for example: /RD. A "0" represents a logic-zero or low-level signal, while a "1" represents a logic-one or high-level signal.

### Declaration of Electro Magnetic Conformity of the PHYTEC phyCORE-AM3517



PHYTEC System on Modules (SOMs) are designed for installation in electrical appliances or, combined with the PHYTEC Carrier Board, can be used as dedicated Evaluation Boards (for use as a test and prototype platform for hardware/software development) in laboratory environments.

#### CAUTION:

PHYTEC products lacking protective enclosures are subject to damage by ESD and, hence, may only be unpacked, handled or operated in environments in which sufficient precautionary measures have been taken in respect to ESD-dangers. It is also necessary that only appropriately trained personnel (such as electricians, technicians and engineers) handle and/or operate these products. Moreover, PHYTEC products should not be operated without protection circuitry if connections to the product's pin header rows are longer than 3 m.

PHYTEC products fulfill the norms of the European Union's Directive for Electro Magnetic Conformity only in accordance to the descriptions and rules of usage indicated in this hardware manual (particularly in respect to the pin header row connectors, power connector and serial interface to a host-PC).

Implementation of PHYTEC products into target devices, as well as user modifications and extensions of PHYTEC products, is subject to renewed establishment of conformity to, and certification of, Electro Magnetic Directives. Users should ensure conformance following any modifications to the products as well as implementation of the products into target systems.

The phyCORE-AM3517 is one of a series of PHYTEC System on Modules that can be populated with different controllers and, hence, offers various functions and configurations. PHYTEC supports a variety of 8-/16- and 32-bit controllers in two ways:

1. As the basis for Rapid Development Kits which serve as a reference and evaluation platform.
2. As insert-ready, fully functional phyCORE OEM modules, which can be embedded directly into the user's peripheral hardware design.

Implementation of an OEM-able SOM subassembly as the "core" of your embedded design allows you to focus on hardware peripherals and firmware without expending resources to "re-invent" microcontroller circuitry. Furthermore, much of the value of the phyCORE module lies in its layout and test.

Production-ready Board Support Packages (BSPs) and Design Services for our hardware further reduce development time and expenses. Take advantage of PHYTEC products to shorten time-to-market, reduce development costs, and avoid substantial design issues and risks. For more information go to:

<http://www.phytec.com/services/design-services/index.html>

---

# **Part I: PCM-048/phyCORE-AM3517 System on Module**

---

Part 1 of this three part manual provides detailed information on the phyCORE-AM3517 System on Module (SOM) designed for custom integration into customer applications.

The information in the following chapters is applicable to the 1335.1 PCB revision of the phyCORE-AM3517 SOM.

## 1 Introduction

The phyCORE-AM3517 belongs to PHYTEC's phyCORE System on Module (SOM) family. The phyCORE SOMs represent the continuous development of PHYTEC SOM technology. Like its mini-, micro-, and nanoMODUL predecessors, the phyCORE boards integrate all core elements of a microcontroller system on a subminiature board and are designed in a manner that ensures their easy expansion and embedding in peripheral hardware developments.

As independent research indicates that approximately 70% of all EMI (Electro Magnetic Interference) problems stem from insufficient supply voltage grounding of electronic components in high frequency environments, the phyCORE board design features an increased pin package. The increased pin package allows dedication of approximately 20% of all connector pins on the phyCORE boards to ground. This improves EMI and EMC characteristics and makes it easier to design complex applications meeting EMI and EMC guidelines using phyCORE boards even in high noise environments.

phyCORE boards achieve their small size through modern SMD technology and multi-layer design. In accordance with the complexity of the module, 0402-packaged SMD components and laser-drilled Microvias are used on the boards, providing phyCORE users with access to this cutting edge miniaturization technology for integration into their own design.

The phyCORE-AM3517 is a sub-miniature (72 x 58 mm) insert-ready SOM populated with Texas Instruments AM3517 ARM Cortex-A8 core processor. Its universal design enables its insertion into a wide range of embedded applications. All processor signals and ports extend from the processor to high-density pitch (0.635 mm) connectors aligning two sides of the board. This allows the SOM to be plugged like a "big chip" into a target application.

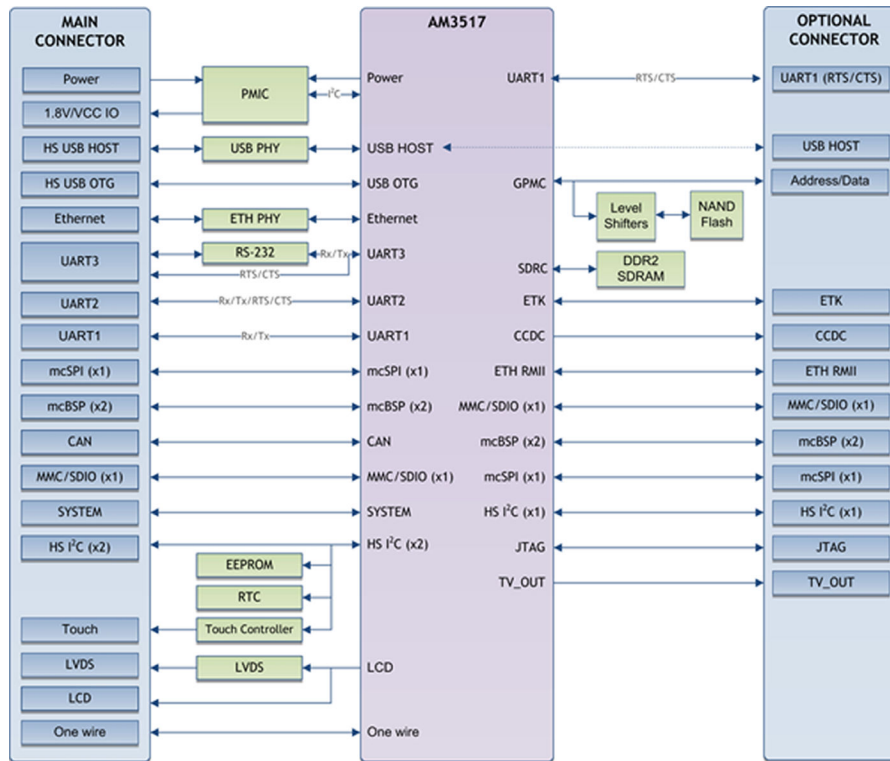
Precise specifications for the processor populating the board can be found in the applicable processor user's manual and datasheet. The descriptions in this manual are based on the Texas Instruments ARM Cortex A8/AM3517 processor. No description of compatible processor derivative functions is included, as such functions are not relevant for the basic functioning of the phyCORE-AM3517.

### **The phyCORE-AM3517 offers the following features:**

- Insert-ready, sub-miniature (72 x 58 mm) System on Module (SOM) subassembly in low EMI design, achieved through advanced SMD technology
- Populated with the Texas Instruments AM3517 processor (491-ball BGA packaging)
- Improved interference safety achieved through multi-layer PCB technology and dedicated ground pins
- Controller signals and ports extend to two 160-pin high-density (0.635 mm) Molex connectors aligning two sides of the board, enabling it to be plugged like a "big chip" into target application
- Maximum 600 MHz core clock frequency
- NEON (TM) SIMD co-processor and Vector Floating Point (VFP) co-processor
- 16KB instruction cache (4-way set-associative)
- 16KB data cache (4-way set-associative)
- 256KB L2 cache
- System direct memory access (sDMA) controller (32 logical channels with configurable priority)
- Memory Management Unit (MMU)
- 32-bit DDR2-333MHz, 256 or 512MByte SDRAM running at 1.8V
- General Purpose Memory Controller supporting 16-bit wide multiplexed address/data bus
- 12 32-bit General Purpose Timers
- 64 KB SRAM
- 128, 256, or 512 MB of on-board NAND flash at 1.8V (bootable)
- HD resolution display subsystem:
  - Parallel Digital Output
  - Up to 24-Bit RGB

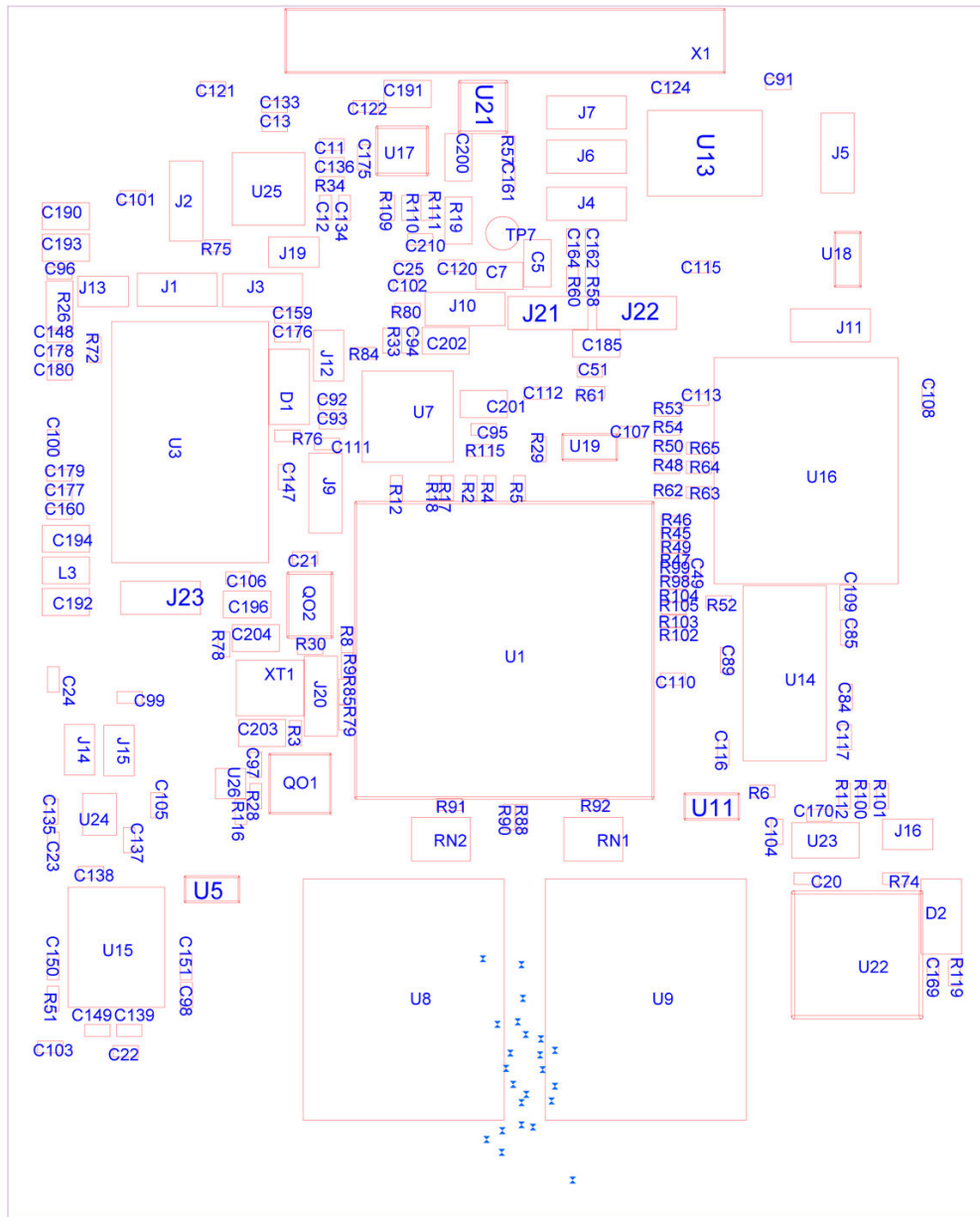
- Supports up to two LCD Panels
- Support for Remote Frame Buffer Interface (RFB) LCD Panels supporting
- Two 10-bit Digital-to-Analog Converters (DACs) supporting Composite NTSC/PAL Video and Luma/Chroma Separate Video (S-Video)
- Rotation 90, 180, and 270 degrees; image resizing from 1/4x to 8x
- Color Space Converter
- 8-bit Alpha Blending
- Video Processing Front End (VPFE) 16-bit video input port:
  - RAW data interface
  - 75-MHz maximum pixel clock
  - Supports REC656/CCIR656 standard chip
  - Supports YCbCr422 format (8-bit or 16-bit with discrete horizontal and vertical sync signals)
  - Generates optical black clamping signals
  - Built-in digital clamping and black level compensation
  - 10-bit to 8-bit A-law compression hardware
  - Up to 16K Pixels (Image Size) in horizontal and vertical directions
- 10/100 Mbit Ethernet (MAC and PHY)
- Multiport USB Host Subsystem [HS/FS/LS] DP/DM interface
- USB OTG transceiver for embedded USB host/peripheral functionality
- High-End CAN Controller (HECC)
- Six rail voltage supervision PMIC with programmable processor core voltage support and RTC priority voltage switch
- One 32-bit Watchdog Timer (internal to AM3517)
- Support for RealView ICE debug through standard JTAG interface
- Four Master/Slave Multichannel Serial Port Interface (McSPI) ports
- Five Multichannel Buffered Serial Ports: one 5K-Byte Transmit/Receive Buffer (McBSP2) and four 512-Byte transmit/receive buffers (McBSP1/3/4/5)
- Three Master/Slave high-speed Inter-Integrated circuit (I<sup>2</sup>C) controllers
- Two I<sup>2</sup>C ports
- 10/100 Ethernet with HP Auto MDIX support
- 24-bit LCD controller supporting STN and TFT panels at up to 1024x768 display resolution at 60Hz and 2048x2048 resolution at lower frame rates (PCLK max 75MHz).
- Touch screen controller
- Three removable media interfaces [MMC/SD/SDIO]
- Real-time clock (RTC) with dedicated interrupt (alarm clock function) and processor independent RTC consuming less than 275nA at 3.0V typical
- Boot from NAND, USB, MMC/SDIO, Ethernet, and more
- JTAG interface for debugging and download of user code
- Up to 186 General-Purpose I/O (GPIO) pins
- Configurable IO voltage of 1.8V or 3.3V
- Single input supply voltage of 3.3 to 5.0V
- Industrial temperature range (-40C to +85C)

## 1.1 Block Diagram

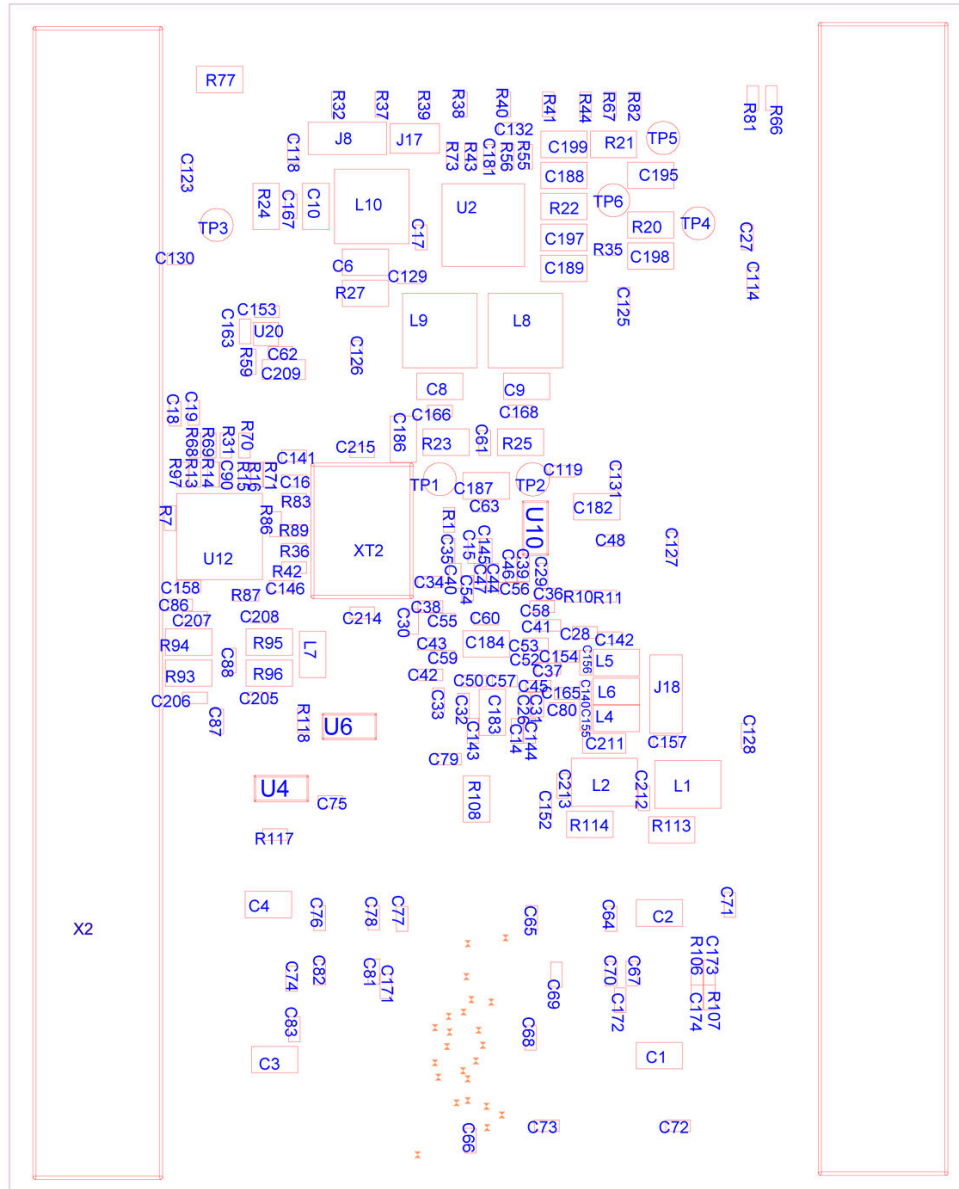


**Fig. 1-1.** phyCORE-AM3517 Block Diagram

### 1.2 View of the phyCORE-AM3517



**Fig. 1-2. Top View of the phyCORE-AM3517 (Controller Side)**



**Fig. 1-3. Bottom View of the phyCORE-AM3517 (Connector Side)**



---

## 2 Pin Description

Please note that all module connections are not to exceed their expressed maximum voltage or current. Maximum signal input values are indicated in the corresponding controller manuals/datasheets. As damage from improper connections varies according to use and application, it is the user's responsibility to take appropriate safety measures to ensure that the module connections are protected from overloading through connected peripherals.

All controller signals extend to surface mount technology (SMT) connectors (0.635 mm) lining two sides of the module (referred to as the phyCORE-Connector). This allows the phyCORE-AM3517 to be plugged into any target application like a "big chip."

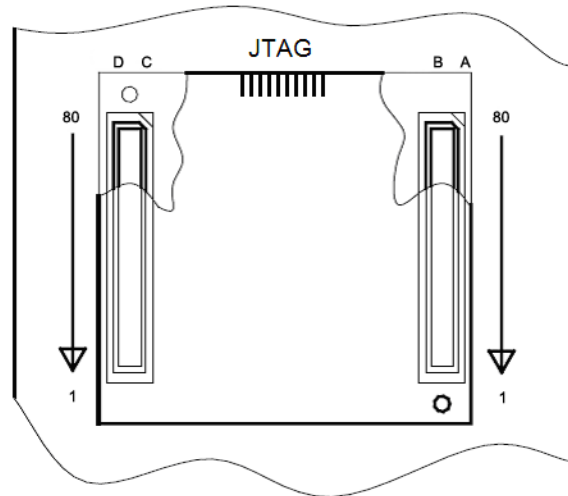
The numbering scheme for the phyCORE-Connector is based on a two dimensional matrix in which column positions are identified by a letter and row position by a number. Pin 1A, for example, is always located in the upper left hand corner of the matrix. The pin numbering values increase moving down on the board. Lettering of the pin connector rows progresses alphabetically from left to right (refer to [Figure 2-1](#)).

The numbered matrix can be aligned with the phyCORE-AM3517 (viewed from above; phyCORE-Connector pointing down) or with the socket of the corresponding phyCORE Carrier Board/user target circuitry. The upper left-hand corner of the numbered matrix (pin 1A) is thus covered with the corner of the phyCORE-AM3517 marked with a number 1. The numbering scheme is always in relation to the PCB as viewed from above, even if all connector contacts extend to the bottom of the module.

The numbering scheme is thus consistent for both the module's phyCORE-Connector as well as mating connectors on the phyCORE Carrier Board or target hardware, thereby considerably reducing the risk of pin identification errors.

Since the pins are exactly defined according to the numbered matrix previously described, the phyCORE-Connector is usually assigned a single designator for its position (X2 for example). In this manner the phyCORE-Connector comprises a single, logical unit regardless of the fact that it could consist of more than one physical socketed connector. The location of row 1 on the board is marked by a number 1 on the PCB to allow easy identification.

[Figure 2-1](#) illustrates the numbered matrix system. It shows a phyCORE-AM3517 with SMT phyCORE-Connectors on its underside (defined as dotted lines) mounted on a Carrier Board. In order to facilitate understanding of the pin assignment scheme, the diagram presents a cross-view of the phyCORE module showing these phyCORE-Connectors mounted on the underside of the module's PCB.



**Fig. 2-1.** Pin-out of the phyCORE-Connector (Top View, with Cross Section Insert)

**Table 2-1.** Pin Descriptions, phyCORE-Connector X2, Row A

Pin	Signal	I/O	Signal Level	Description
1A	GPMC_NCS7	O	VDDSHV	GPMC interface - control (active low chip select 7)
2A	GND	-	-	Ground
3A	GPMC_NCS3	O	VDDSHV	GPMC interface - control (active low chip select 3)
4A	GPMC_NCS2	O	VDDSHV	GPMC interface - control (active low chip select 2)
5A	GPMC_NCS1	O	VDDSHV	GPMC interface - control (active low chip select 1)
6A	xGPMC_NWE	O	VDDSHV	GPMC interface - control (active low write enable)
7A	GND	-	-	Ground
8A	GPMC_NBE0_CLE	O	VDDSHV	GPMC interface - control (active low bus enable 0)
9A	GPMC_NBE1	O	VDDSHV	GPMC interface - control (active low bus enable 1)
10A	GPMC_WAIT0	I	VDDSHV	GPMC interface - control (active low wait signal)
11A	GPMC_WAIT2	I	VDDSHV	GPMC interface - control (active low wait signal)
12A	GND	-	-	Ground
13A	GPMC_A9	O	VDDSHV	GPMC interface - address
14A	GPMC_A8	O	VDDSHV	GPMC interface - address
15A	GPMC_A7	O	VDDSHV	GPMC interface - address
16A	GPMC_A4	O	VDDSHV	GPMC interface - address
17A	GND	-	-	Ground
18A	GPMC_A1	O	VDDSHV	GPMC interface - address
19A	GPMC_D15	I	VDDSHV	GPMC interface - data
20A	GPMC_D14	I	VDDSHV	GPMC interface - data
21A	GPMC_D11	I	VDDSHV	GPMC interface - data
22A	GND	-	-	Ground

**Table 2-1. Pin Descriptions, phyCORE-Connector X2, Row A (Continued)**

Pin	Signal	I/O	Signal Level	Description
23A	GPMC_D8	I	VDDSHV	GPMC interface - data
24A	GPMC_D7	I	VDDSHV	GPMC interface - data
25A	GPMC_D6	I	VDDSHV	GPMC interface - data
26A	GPMC_D3	I	VDDSHV	GPMC interface - data
27A	GND	-	-	Ground
28A	GPMC_D0	I	VDDSHV	GPMC interface - data
29A	CCDC_WEN	I	VDDSHV	CCD Camera interface - control (write enable)
30A	CCDC_VD	IO	VDDSHV	CCD Camera interface - control (vertical sync)
31A	CCDC_FIELD	IO	VDDSHV	CCD Camera interface - control (field identification)
32A	GND	-	-	Ground
33A	CCDC_DATA5	I	VDDSHV	CCD Camera interface - data
34A	CCDC_DATA4	I	VDDSHV	CCD Camera interface - data
35A	CCDC_DATA3	I	VDDSHV	CCD Camera interface - data
36A	CCDC_DATA0	I	VDDSHV	CCD Camera interface - data
37A	GND	-	-	Ground
38A	RMII_MDIO_CLK	O	VDDSHV	Ethernet - MDIO interface clock
39A	RMII_MDIO_DATA	IO	VDDSHV	Ethernet - MDIO interface data
40A	RMII_RXD1	I	VDDSHV	Ethernet MAC - RMII data RX data
41A	RMII_RXER	I	VDDSHV	Ethernet MAC - RMII data RX error
42A	GND	-	-	Ground
43A	ETK_D15	O	VDDSHV	ARM Embedded Toolkit debug interface (other signal on HSUSB interface)
44A	ETK_D14	O	VDDSHV	ARM Embedded Toolkit debug interface (other signal on HSUSB interface)
45A	ETK_D13	O	VDDSHV	ARM Embedded Toolkit debug interface (other signal on HSUSB interface)
46A	ETK_D10	O	VDDSHV	ARM Embedded Toolkit debug interface (other signal on HSUSB interface)
47A	GND	-	-	Ground
48A	HSUSB1_DATA3	IO	VDDSHV	High Speed USB digital interface - data
49A	HSUSB1_DATA6	IO	VDDSHV	High Speed USB digital interface - data
50A	HSUSB1_DATA5	IO	VDDSHV	High Speed USB digital interface - data
51A	HSUSB1_DATA2	IO	VDDSHV	High Speed USB digital interface - data
52A	GND	-	-	Ground
53A	HSUSB1_STP	O	VDDSHV	High Speed USB digital interface - control
54A	xHSUSB1_CLK	O	VDDSHV	High speed USB digital interface 1 - clock
55A	MMC2_DAT7	IO	VDDSHV	MMC / SDIO 2 interface - data
56A	MMC2_DAT4	IO	VDDSHV	MMC / SDIO 2 interface - data

**Table 2-1. Pin Descriptions, phyCORE-Connector X2, Row A (Continued)**

Pin	Signal	I/O	Signal Level	Description
57A	GND	-	-	Ground
58A	MMC2_DAT1	IO	VDDSHV	MMC / SDIO 2 interface - data
59A	MMC2_DAT0	IO	VDDSHV	MMC / SDIO 2 interface - data
60A	MMC2_CMD	O	VDDSHV	MMC / SDIO 2 interface - command
61A	MCSPi2_CS1	O	VDDSHV	Multichannel Serial Peripheral Interface 2 - chip select 1
62A	GND	-	-	Ground
63A	MCSPi2_CS0	IO	VDDSHV	Multichannel Serial Peripheral Interface 2 - chip select 0
64A	MCSPi2_SIMO	IO	VDDSHV	Multichannel Serial Peripheral Interface 2 - slave data in, master data out
65A	MCSPi2_SOMI	IO	VDDSHV	Multichannel Serial Peripheral Interface 2 - slave data out, master data in
66A	xMCSPi2_CLK	IO	VDDSHV	Multichannel Buffered Serial Port 2 - clock
67A	GND	-	-	Ground
68A	TV_OUT1	O	Analog	TV Out signal 1
69A	TV_OUT2	O	Analog	TV Out signal 2
70A	MCBSP4_CLKX	IO	VDDSHV	Multichannel Buffered Serial Port 4 - TX clock
71A	MCBSP4_DR	I	VDDSHV	Multichannel Buffered Serial Port 4 - data receive
72A	GND	-	-	Ground
73A	MCBSP4_DX	IO	VDDSHV	Multichannel Buffered Serial Port 4 - data transmit
74A	MCBSP4_FSX	IO	VDDSHV	Multichannel Buffered Serial Port 4 - frame sync transmit
75A	N/C	-	-	No connect
76A	JTAG_EMU0	IO	VDDSHV	JTAG - test emulation
77A	GND	-	-	Ground
78A	JTAG_NTRST	I	VDDSHV	JTAG - test reset
79A	JTAG_TDI	I	VDDSHV	JTAG - test data in
80A	xJTAG_TDO	O	VDDSHV	JTAG - test data out

**Table 2-2. Pin Descriptions, phyCORE-Connector X2, Row B**

Pin	Signal	I/O	Signal Level	Description
1B	GPMC_NCS6	O	VDDSHV	GPMC interface - control
2B	GPMC_NCS5	O	VDDSHV	GPMC interface - control
3B	GPMC_NCS4	O	VDDSHV	GPMC interface - control
4B	GND	-	-	Ground
5B	N/C	-	-	No connect

**Table 2-2. Pin Descriptions, phyCORE-Connector X2, Row B (Continued)**

Pin	Signal	I/O	Signal Level	Description
6B	GPMC_NWP	O	VDDSHV	GPMC interface - control (active low write protect)
7B	GPMC_NOE	O	VDDSHV	GPMC interface - control (active low output enable)
8B	xGPMC_NADV_ALE	O	VDDSHV	GPMC interface - control
9B	GND	-	-	Ground
10B	GPMC_WAIT1	I	VDDSHV	GPMC interface - control (active low wait)
11B	GPMC_WAIT3	I	VDDSHV	GPMC interface - control (active low wait)
12B	xGPMC_CLK	O	VDDSHV	GPMC interface - clock
13B	GPMC_A10	O	VDDSHV	GPMC interface - address
14B	GND	-	-	Ground
15B	GPMC_A6	O	VDDSHV	GPMC interface - address
16B	GPMC_A5	O	VDDSHV	GPMC interface - address
17B	GPMC_A3	O	VDDSHV	GPMC interface - address
18B	GPMC_A2	O	VDDSHV	GPMC interface - address
19B	GND	-	-	Ground
20B	GPMC_D13	I	VDDSHV	GPMC interface - data
21B	GPMC_D12	I	VDDSHV	GPMC interface - data
22B	GPMC_D10	I	VDDSHV	GPMC interface - data
23B	GPMC_D9	I	VDDSHV	GPMC interface - data
24B	GND	-	-	Ground
25B	GPMC_D5	I	VDDSHV	GPMC interface - data
26B	GPMC_D4	I	VDDSHV	GPMC interface - data
27B	GPMC_D2	I	VDDSHV	GPMC interface - data
28B	GPMC_D1	I	VDDSHV	GPMC interface - data
29B	GND	-	-	Ground
30B	CCDC_PCLK	IO	VDDSHV	CCD Camera interface - control (pixel clock)
31B	CCDC_HD	IO	VDDSHV	CCD Camera interface - control (horizontal sync)
32B	CCDC_DATA7	I	VDDSHV	CCD Camera interface - data
33B	CCDC_DATA6	I	VDDSHV	CCD Camera interface - data
34B	GND	-	-	Ground
35B	CCDC_DATA2	I	VDDSHV	CCD Camera interface - data
36B	CCDC_DATA1	I	VDDSHV	CCD Camera interface - data
37B	RMII_50MHZ_CLK	I	VDDSHV	Ethernet MAC - RMII clock
38B	RMII_CRS_DV	I	VDDSHV	Ethernet MAC - RMII data valid
39B	GND	-	-	Ground
40B	RMII_RXD0	I	VDDSHV	Ethernet MAC - RMII data RX data
41B	RMII_TXD1	O	VDDSHV	Ethernet MAC - RMII data TX data
42B	RMII_TXD0	O	VDDSHV	Ethernet MAC - RMII data TX data
43B	RMII_TXEN	O	VDDSHV	Ethernet MAC - RMII data TX enable

**Table 2-2. Pin Descriptions, phyCORE-Connector X2, Row B (Continued)**

Pin	Signal	I/O	Signal Level	Description
44B	GND	-	-	Ground
45B	ETK_D12	O	VDDSHV	ARM Embedded Toolkit debug interface (other signal on HSUSB interface)
46B	ETK_D11	O	VDDSHV	ARM Embedded Toolkit debug interface (other signal on HSUSB interface)
47B	HSUSB1_NXT	I	VDDSHV	High Speed USB digital interface - control
48B	HSUSB1_DIR	I	VDDSHV	High Speed USB digital interface - control
49B	GND	-	-	Ground
50B	HSUSB1_DATA4	IO	VDDSHV	High Speed USB digital interface - data
51B	HSUSB1_DATA7	IO	VDDSHV	High Speed USB digital interface - data
52B	HSUSB1_DATA1	IO	VDDSHV	High Speed USB digital interface - data
53B	HSUSB1_DATA0	IO	VDDSHV	High Speed USB digital interface - data
54B	GND	-	-	Ground
55B	MMC2_DAT6	IO	VDDSHV	MMC / SDIO 2 interface - data
56B	MMC2_DAT5	IO	VDDSHV	MMC / SDIO 2 interface - data
57B	MMC2_DAT3	IO	VDDSHV	MMC / SDIO 2 interface - data
58B	MMC2_DAT2	IO	VDDSHV	MMC / SDIO 2 interface - data
59B	GND	-	-	Ground
60B	xMMC2_CLK	O	VDDSHV	MMC / SDIO 2 interface - clock
61B	I2C3_SCL	O	VDDSHV	I <sup>2</sup> C bus 3 clock
62B	I2C3_SDA	IO	VDDSHV	I <sup>2</sup> C bus 3 data
63B	UART1_RTS	O	VDDSHV	UART 1 ready to send
64B	GND	-	-	Ground
65B	UART1_CTS	I	VDDSHV	UART 1 clear to send
66B	N/C	-	-	No connect
67B	N/C	-	-	No connect
68B	N/C	-	-	No connect
69B	GND	-	-	Ground
70B	MCBSP3_CLKX	IO	VDDSHV	Multichannel Buffered Serial Port 3 - TX clock
71B	MCBSP3_DR	I	VDDSHV	Multichannel Buffered Serial Port 3 - data receive
72B	MCBSP3_DX	IO	VDDSHV	Multichannel Buffered Serial Port 3 - data transmit
73B	MCBSP3_FSX	IO	VDDSHV	Multichannel Buffered Serial Port 3 - frame sync transmit
74B	GND	-	-	Ground
75B	N/C	-	-	No connect
76B	JTAG_EMU1	IO	VDDSHV	JTAG - test emulation
77B	xJTAG_RTCK	O	VDDSHV	JTAG - test clock - ARM clock emulation

**Table 2-2. Pin Descriptions, phyCORE-Connector X2, Row B (Continued)**

Pin	Signal	I/O	Signal Level	Description
78B	JTAG_TCK	I	VDDSHV	JTAG - test clock
79B	GND	-	-	Ground
80B	JTAG_TMS	IO	VDDSHV	JTAG - test mode select

**Table 2-3. Pin Descriptions, phyCORE-Connector X2, Row C**

Pin	Signal	I/O	Signal Level	Description
1C	VIN	I	VIN	3.3V-5.0 power input
2C	VIN	I	VIN	3.3V-5.0 power input
3C	GND	-	-	Ground
4C	VIN_3V3	I	VIN_3V3	3.3V power input
5C	VIN_3V3	I	VIN_3V3	3.3V power input
6C	VBAT	I	Power	Battery connection to PMIC switch supplying power to the VRTC
7C	GND	-	-	Ground
8C	/RESET	OD	VIN	Active low reset out (open drain), normally connected to other open drain reset control inputs; this signal indicates all power supplies on the SOM are within regulation
9C	xSYS_NRESWARM	IO D	VDDSHV	Active low processor warm reset (input / open drain output)
10C	xSYS_CLKOUT1	O	VDDSHV	System clock out 1
11C	SYS_BOOT6	I	VDDSHV	Boot configuration (sampled at reset)
12C	GND	-	-	Ground
13C	SYS_BOOT4	I	VDDSHV	Boot configuration (sampled at reset)
14C	SYS_BOOT3	I	VDDSHV	Boot configuration (sampled at reset)
15C	UART1_RX	I	VDDSHV	UART 1 receive data into SOM
16C	UART1_TX	O	VDDSHV	UART 1 transmit data from SOM
17C	GND	-	-	Ground
18C	ENET_TXP	O	Analog	Ethernet Differential (transmit positive)
19C	ENET_TXN	O	Analog	Ethernet Differential (transmit negative)
20C	ENET_RXP	I	Analog	Ethernet Differential (receive positive)
21C	ENET_RXN	I	Analog	Ethernet Differential (receive negative)
22C	GND	-	-	Ground
23C	MMC1_DAT7	IO	VDDSHV	MMC / SDIO 1 interface - data
24C	MMC1_DAT6	IO	VDDSHV	MMC / SDIO 1 interface - data
25C	MMC1_DAT4	IO	VDDSHV	MMC / SDIO 1 interface - data
26C	MMC1_DAT3	IO	VDDSHV	MMC / SDIO 1 interface - data

**Table 2-3. Pin Descriptions, phyCORE-Connector X2, Row C (Continued)**

Pin	Signal	I/O	Signal Level	Description
27C	GND	-	-	Ground
28C	xCSP11_CLK	IO	VDDSHV	Multichannel Buffered Serial Port 1 - clock
29C	MCSP11_SOMI	IO	VDDSHV	Multichannel Serial Peripheral Interface 1 - Slave data out, Master data in
30C	MCSP11_CS3	O	VDDSHV	Multichannel Serial Peripheral Interface 1 - chip select 0
31C	MCSP11_CS2	O	VDDSHV	Multichannel Serial Peripheral Interface 1 - chip select 2
32C	GND	-	-	Ground
33C	MCBSP2_DX	IO	VDDSHV	Multichannel Buffered Serial Port 2 - data transmit
34C	MCBSP2_DR	I	VDDSHV	Multichannel Buffered Serial Port 2 - data receive
35C	MCBSP2_CLKX	IO	VDDSHV	Multichannel Buffered Serial Port 2 - TX clock
36C	MCBSP1_FSR	IO	VDDSHV	Multichannel Buffered Serial Port 1 - frame sync receive
37C	GND	-	-	Ground
38C	MCBSP1_CLKR	IO	VDDSHV	Multichannel Buffered Serial Port 1 - RX clock
39C	MCBSP_CLKS	IO	VDDSHV	Multichannel Buffered Serial Port - clock
40C	UART3_TX_RS232	O	RS232/ VDDSHV <sup>a</sup>	UART 3 transmit at RS-232 levels
41C	UART3_RX_RS232	I	RS232/ VDDSHV <sup>a</sup>	UART 3 receive at RS-232 levels
42C	GND	-	-	Ground
43C	UART2_CTS	I	VDDSHV	UART 2 clear to send
44C	UART2_RTS	O	VDDSHV	UART 2 ready to send
45C	UART2_TX	O	VDDSHV	UART 2 transmit
46C	UART2_RX	I	VDDSHV	UART 2 receive
47C	GND	-	-	Ground
48C	HECC1_TXD	O	VDDSHV	High-end CAN transmit
49C	HECC1_RXD	I	VDDSHV	High-end CAN receive
50C	I2C2_SDA	IO	VDDSHV	I <sup>2</sup> C bus 2 data
51C	I2C2_SCL	O	VDDSHV	I <sup>2</sup> C bus 2 clock
52C	GND	-	-	Ground
53C	I2C1_SDA	IO	VDDSHV	I <sup>2</sup> C bus 1 data
54C	I2C1_SCL	O	VDDSHV	I <sup>2</sup> C bus 1 clock
55C	DSS_VSYNC	O	VDDSHV	Display Sub-System - control
56C	DSS_HSYNC	O	VDDSHV	Display Sub-System - control
57C	GND	-	-	Ground
58C	DSS_DATA21	O	VDDSHV	Display Sub-System - data
59C	DSS_DATA20	O	VDDSHV	Display Sub-System - data
60C	DSS_DATA18	O	VDDSHV	Display Sub-System - data
61C	DSS_DATA17	O	VDDSHV	Display Sub-System - data



**Table 2-3. Pin Descriptions, phyCORE-Connector X2, Row C (Continued)**

Pin	Signal	I/O	Signal Level	Description
62C	GND	-	-	Ground
63C	DSS_DATA13	O	VDDSHV	Display Sub-System - data
64C	DSS_DATA12	O	VDDSHV	Display Sub-System - data
65C	DSS_DATA10	O	VDDSHV	Display Sub-System - data
66C	DSS_DATA9	O	VDDSHV	Display Sub-System - data
67C	GND	-	-	Ground
68C	DSS_DATA5	O	VDDSHV	Display Sub-System - data
69C	DSS_DATA4	O	VDDSHV	Display Sub-System - data
70C	DSS_DATA2	O	VDDSHV	Display Sub-System - data
71C	DSS_DATA1	O	VDDSHV	Display Sub-System - data
72C	GND	-	-	Ground
73C	LCD_LVDS_Y3P	O	Analog	LCD LVDS - data
74C	LCD_LVDS_Y3M	O	Analog	LCD LVDS - data
75C	LCD_LVDS_Y2P	O	Analog	LCD LVDS - data
76C	LCD_LVDS_Y2M	O	Analog	LCD LVDS - data
77C	GND	-	-	Ground
78C	TOUCH_X+	I	Analog	Touch panel X direction positive
79C	TOUCH_X-	I	Analog	Touch panel X direction negative
80C	TOUCH_Y+	I	Analog	Touch panel Y direction positive

a. The default level for these signals is consistent with the RS-232 standard, but can be optionally configured to VDDSHV voltage levels of 3.3V or 1.8V

**Table 2-4. Pin Descriptions, phyCORE-Connector X2, Row D**

Pin	Signal	I/O	Signal Level	Description
1D	VIN	I	VIN	3.3V-5.0 power input
2D	VIN	I	VIN	3.3V-5.0 power input
3D	GND	-	-	Ground
4D	VCC_1V8	O	VCC_1V8	1.8V output voltage
5D	VCC_1V8	O	VCC_1V8	1.8V output voltage
6D	VDDSHV	O	VDDSHV	IO voltage output
7D	VDDSHV	O	VDDSHV	IO voltage output
8D	SYS_NIRQ	I	VDDSHV	Interrupt to AM3517 (dedicated interrupt)
9D	GND	-	-	Ground
10D	/RESIN	I	VIN	System reset input; connect this pin to an open drain output and momentarily pull low to initiate a system reset. Do not connect this pin to a push-pull output or any other pull-up/pull-down circuitry.
11D	SYS_CLKREQ	I		Do not use

**Table 2-4. Pin Descriptions, phyCORE-Connector X2, Row D (Continued)**

Pin	Signal	I/O	Signal Level	Description
12D	xSYS_CLKOUT2	O	VDDSHV	System clock out 1
13D	SYS_BOOT5	I	VDDSHV	Boot configuration (sampled at reset)
14D	GND	-	-	Ground
15D	SYS_BOOT2	I	VDDSHV	Boot configuration (sampled at reset)
16D	SYS_BOOT1	I	VDDSHV	Boot configuration (sampled at reset)
17D	SYS_BOOT0	I	VDDSHV	Boot configuration (sampled at reset)
18D	HDQ_SIO	IO	VDDSHV	HDQ / single wire interface (Bi-directional control and data interface, open drain output)
19D	GND	-	-	Ground
20D	ENET_LINK	O	3.3V	Ethernet Link status output; typically connected to an LED on the carrier board to indicate Ethernet link status
21D	ENET_SPEED	O	3.3V	Ethernet activity status output; typically connected to an LED on the Carrier Board to indicate Ethernet activity status
22D	xMMC1_CLK	O	VDDSHV	MMC / SDIO 1 interface - clock
23D	MMC1_CMD	O	VDDSHV	MMC / SDIO 1 interface - command
24D	GND	-	-	Ground
25D	MMC1_DAT5	IO	VDDSHV	MMC / SDIO 1 interface - data
26D	MMC1_DAT2	IO	VDDSHV	MMC / SDIO 1 interface - data
27D	MMC1_DAT1	IO	VDDSHV	MMC / SDIO 1 interface - data
28D	MMC1_DAT0	IO	VDDSHV	MMC / SDIO 1 interface - data
29D	GND	-	-	Ground
30D	MCSP11_SIMO	IO	VDDSHV	Multichannel Serial Peripheral Interface 1 - Slave data in, Master data out
31D	MCSP11_CS1	O	VDDSHV	Multichannel Serial Peripheral Interface 1 - chip select 1
32D	MCSP11_CS0	IO	VDDSHV	Multichannel Serial Peripheral Interface 1 - chip select 0
33D	MCBSP2_FSX	IO	VDDSHV	Multichannel Buffered Serial Port 2 - frame sync transmit
34D	GND	-	-	Ground
35D	MCBSP1_FSX	IO	VDDSHV	Multichannel Buffered Serial Port 1 - frame sync transmit
36D	MCBSP1_DX	IO	VDDSHV	Multichannel Buffered Serial Port 1 - data transmit
37D	MCBSP1_DR	I	VDDSHV	Multichannel Buffered Serial Port 1 - data receive
38D	MCBSP1_CLKX	IO	VDDSHV	Multichannel Buffered Serial Port 1 - TX clock
39D	GND	-	-	Ground
40D	/RS232_EN	I	3.3V	Active low UART 3 transceiver disable; ground this signal to conserve power
41D	UART3_RTS	O	VDDSHV	UART 3 ready to send
42D	UART3_CTS	I	VDDSHV	UART 3 clear to send
43D	USB0_DRVVBUS	O	VDDSHV	USB 0 VBUS enable to USB VBUS power supply

**Table 2-4. Pin Descriptions, phyCORE-Connector X2, Row D (Continued)**

Pin	Signal	I/O	Signal Level	Description
44D	GND	-	-	Ground
45D	USB0_ID	A	VBUS	USB 0 ID signal
46D	USB0_VBUS	A	VBUS	USB 0 VBUS sense
47D	USB0_DM	A	Analog	USB 0 communication channel minus
48D	USB0_DP	A	Analog	USB 0 communication channel plus
49D	GND	-	-	Ground
50D	USB1_CPEN	O	VDDSHV	USB 1 VBUS enable
51D	USB1_DM	A	Analog	USB 1 communication channel minus
52D	USB1_DP	A	Analog	USB 1 communication channel plus
53D	xUSB1_VBUS	I	VBUS	USB 1 VBUS voltage sense
54D	GND	-	-	Ground
55D	xDSS_PCLK	O	VDDSHV	Display Sub-System - clock
56D	DSS_ACBIAS	O	VDDSHV	Display Sub-System - AC Bias
57D	DSS_DATA23	O	VDDSHV	Display Sub-System - data
58D	DSS_DATA22	O	VDDSHV	Display Sub-System - data
59D	GND	-	-	Ground
60D	DSS_DATA19	O	VDDSHV	Display Sub-System - data
61D	DSS_DATA16	O	VDDSHV	Display Sub-System - data
62D	DSS_DATA15	O	VDDSHV	Display Sub-System - data
63D	DSS_DATA14	O	VDDSHV	Display Sub-System - data
64D	GND	-	-	Ground
65D	DSS_DATA11	O	VDDSHV	Display Sub-System - data
66D	DSS_DATA8	O	VDDSHV	Display Sub-System - data
67D	DSS_DATA7	O	VDDSHV	Display Sub-System - data
68D	DSS_DATA6	O	VDDSHV	Display Sub-System - data
69D	GND	-	-	Ground
70D	DSS_DATA3	O	VDDSHV	Display Sub-System - data
71D	DSS_DATA0	O	VDDSHV	Display Sub-System - data
72D	LCD_LVDS_Y4P	O	Analog	LCD LVDS - data
73D	LCD_LVDS_Y4M	O	Analog	LCD LVDS - data
74D	GND	-	-	Ground
75D	LCD_LVDS_Y1P	O	Analog	LCD LVDS - data
76D	LCD_LVDS_Y1M	O	Analog	LCD LVDS - data
77D	LCD_LVDS_CKLOU TP	O	Analog	LCD LVDS - clock plus

**Table 2-4. Pin Descriptions, phyCORE-Connector X2, Row D (Continued)**

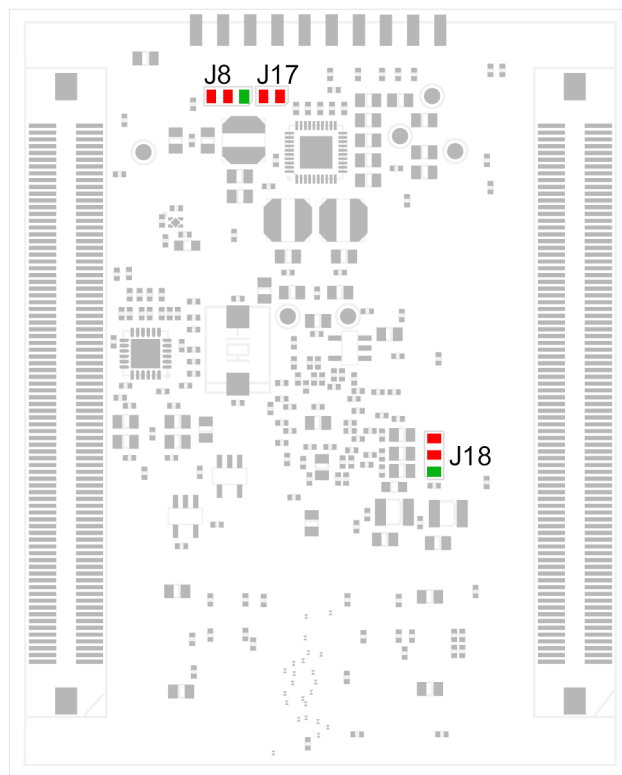
<b>Pin</b>	<b>Signal</b>	<b>I/O</b>	<b>Signal Level</b>	<b>Description</b>
78D	LCD_LVDS_CLKOU TM	O	Analog	LCD LVDS - clock minus
79D	GND	-	-	Ground
80D	TOUCH_Y-	I	Analog	Touch panel Y direction negative signal

### 3 Jumpers

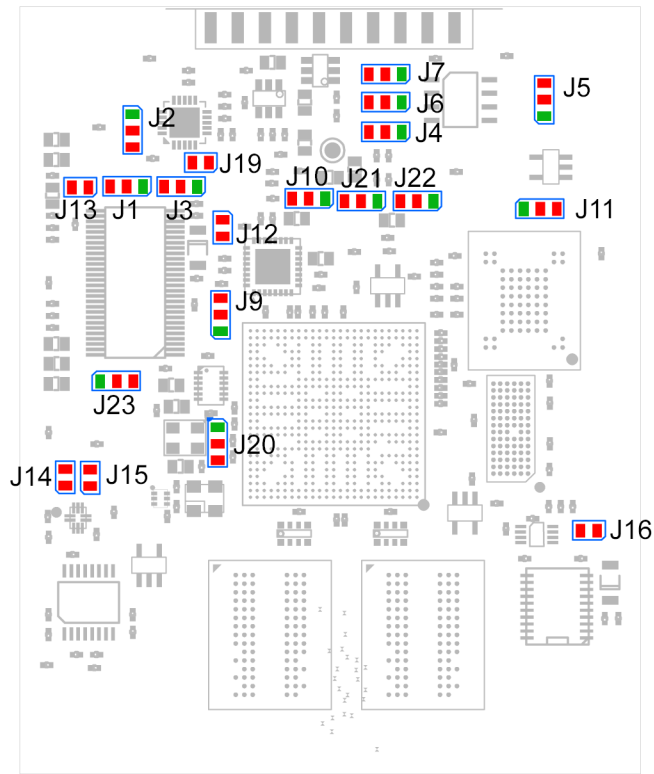
For configuration purposes the phyCORE-AM3517 has 23 solder jumpers, some of which have been installed prior to delivery. [Figure 3-2](#) and [Figure 3-1](#) indicate the location of the solder jumpers on the board. There are 20 solder jumpers located on the top side of the module (opposite side of connectors) and 3 solder jumpers on the bottom side.

If manual jumper modification is required, pay special attention to the "TYPE" column in [Table 3-1](#) ensuring the use of the correct jumper type (0 Ohms, 10k Ohms, etc.). All jumpers are 0805 package with a 1/8W or better power rating.

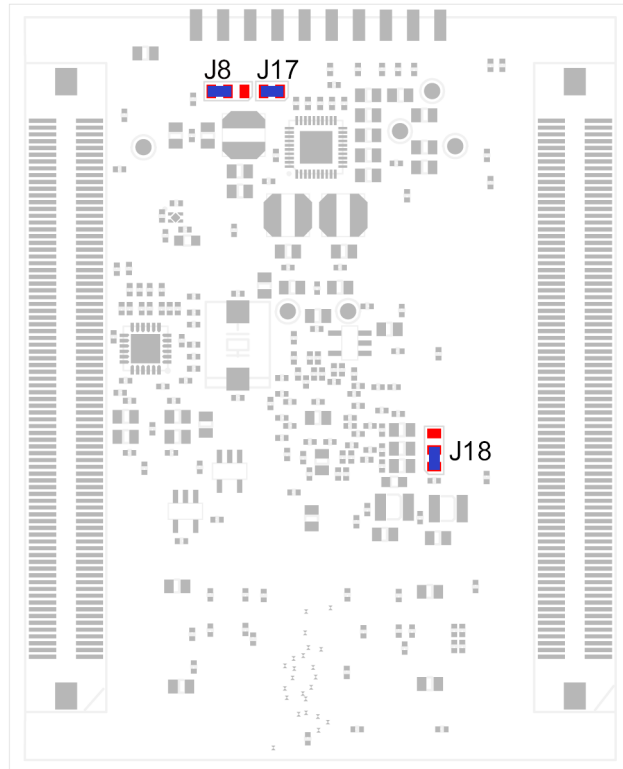
Three and four position jumpers have pin 1 marked with a GREEN pad. Pin 1 can also be identified by the beveled edge on the silk-screen.



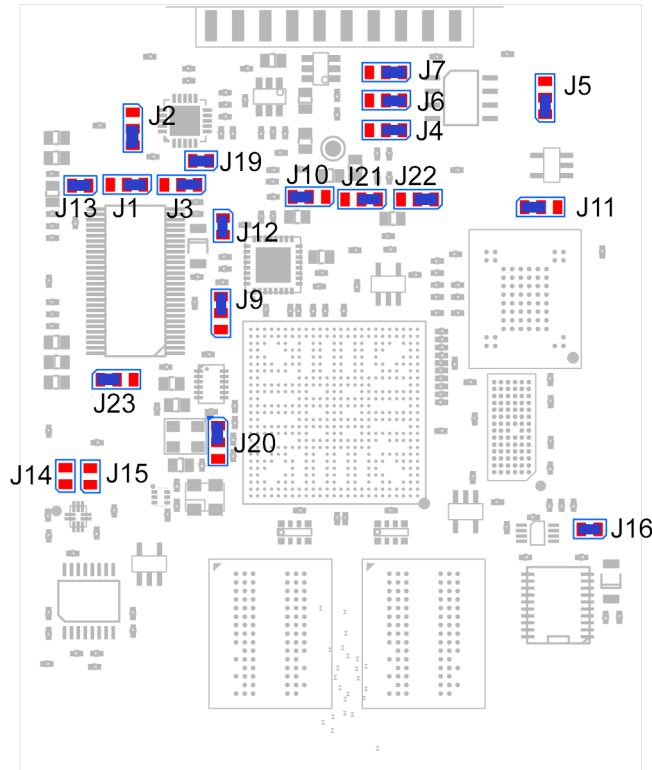
**Fig. 3-1. Jumper Locations (Connector Side)**



**Fig. 3-2. Jumper Locations (Controller Side)**



**Fig. 3-3. Default Jumper Settings (Connector Side)**



**Fig. 3-4. Default Jumper Settings (Controller Side)**

### 3.1 Jumper Settings

Table 3-1 below provides a functional summary of the solder jumpers, their default positions, and possible alternative positions and functions.

A detailed description of each solder jumper can be found in the applicable chapter listed in the table.

**Table 3-1. Jumper Settings**

J	Type	Setting	Description	Chapter
J1	0R	1+2 2+3	Sets clock edge to negative edge on the LVDS encoder U3 Sets clock edge to positive edge on the LVDS encoder U3	11
J2	0R	1+2 2+3	Sets I <sup>2</sup> C lower address bit to 0; AD0 for U25 (touch controller) Sets I <sup>2</sup> C lower address bit to 1; AD0 for U25 (touch controller) default address = 1001 001x	10
J3	0R	1+2 2+3	Sets I <sup>2</sup> C upper address bit to 0; AD1 for U25 (touch controller) default address = 1001 001x Sets I <sup>2</sup> C upper address bit to 1; AD1 for U25 (touch controller)	10
J4	0R	1+2 2+3	Sets I <sup>2</sup> C address bit to 0; A2 for U13 (EEPROM) default address = 1010 000x Sets I <sup>2</sup> C address bit to 1; A2 for U13 (EEPROM)	7.3
J5	0R	1+2 2+3	Sets EEPROM to write protect off Sets EEPROM to write protect on	7.3



**Table 3-1. Jumper Settings (Continued)**

<b>J</b>	<b>Type</b>	<b>Setting</b>	<b>Description</b>	<b>Chapter</b>
<b>J6</b>	0R	<b>1+2</b>	<b>Sets I<sup>2</sup>C address; A1 for U13 (EEPROM) default address = 1010 000x</b>	<b>7.3</b>
		<b>2+3</b>	Sets I <sup>2</sup> C address; A1 for U13 (EEPROM)	
<b>J7</b>	10k	<b>1+2</b>	<b>Sets I<sup>2</sup>C address; A0 for U13 (EEPROM) default address = 1010 000x</b>	<b>7.3</b>
		<b>2+3</b>	Sets I <sup>2</sup> C address lower; A0 for U13 (EEPROM)	
<b>J8</b>	10k	<b>1+2<sup>a</sup></b>	Sets VDDSHV to 1.8V (1.8V SOM required)	<b>13</b>
		<b>2+3</b>	<b>Sets VDDSHV to 3.3V (Standard 3.3V SOM)</b>	
<b>J9</b>	10k	<b>1+2</b>	Reserved	
		<b>2+3</b>	<b>Turns CLKOUT off</b>	
<b>J10</b>	0R	<b>1+2</b>	Sets USB1 PHY to slave	<b>8.3</b>
		<b>2+3</b>	<b>Sets USB1 PHY to host</b>	
<b>J11</b>	0R	<b>1+2</b>	<b>Sets NAND Flash lock off</b>	<b>7.2</b>
		<b>2+3</b>	Sets NAND Flash lock on	
<b>J12</b>	0R	Open	No hardware reset is provided to U7 (USB1 PHY)	<b>8.4</b>
		<b>Closed</b>	<b>AM3517 GPIO_58 provides reset to U7 (USB1 PHY)</b>	
<b>J13</b>	0R	Open	Disables processor access to /Shutdown (low power mode); frees signal for external use as GPIO	
		<b>Closed</b>	<b>Provides SW controlled /Shutdown (low power mode) via GPIO</b>	
<b>J14</b>	0R	<b>Open</b>	<b>UART3 TX operates at RS232 specified transceiver levels</b>	<b>8.1</b>
		Closed	UART3 TX operates at TTL level signaling (U15 must be removed)	
<b>J15</b>	0R	<b>Open</b>	<b>RS232 level bypass RX</b>	<b>8.1</b>
		Closed	Convert to TTL signal level (VDDSHV)	
<b>J16</b>	0R	Open	Disables processor visibility; frees signal for external use as GPIO	<b>5</b>
		<b>Closed</b>	<b>Interrupt from RTC to AM3517</b>	
<b>J17</b>	0R	Open	Disables processor access to system reset	
		<b>Closed</b>	<b>Provides SW controlled system reset via GPIO</b>	
<b>J18</b>	0R	<b>1+2</b>	<b>Power to processor's integrated TV DAC supplied from U17 (external LDO regulator)</b>	<b>4.3</b>
		<b>2+3</b>	Power to processor's integrated TV DAC supplied from U2 (LDO regulator integrated into the PMIC)	
<b>J19</b>	0R	Open	Disables touch screen interrupt to processor; frees signal for external use as GPIO	<b>10</b>
		<b>Closed</b>	<b>Interrupt from touch screen controlled connect to AM3517 GPIO input</b>	
<b>J20</b>	0R	<b>1+2</b>	<b>Selects the 26.000MHz crystal as the clock source to the processor</b>	<b>22</b>
		<b>2+3<sup>b</sup></b>	Selects the 26.000MHz oscillator as the clock source to the processor	

**Table 3-1. Jumper Settings (Continued)**

<b>J</b>	<b>Type</b>	<b>Setting</b>	<b>Description</b>	<b>Chapter</b>
<b>J21</b>	0R	<b>1+2</b> 2+3	<b>Defines PMIC rail 1 to be 1.2V</b> Reserved	<b>4.3</b>
<b>J22</b>	0R	<b>1+2</b> 2+3	<b>Defines PMIC rail 3 to be 1.8V</b> Reserved	<b>4.3</b>
<b>J23</b>	0R	<b>1+2</b> 2+3 <sup>a</sup>	<b>Setting determined by J8; Sets LVDS power scheme for use with SN65LVDS93 part</b> Setting determined by J8; Sets LVDS power scheme for use with SN75LVDS83B part	<b>13</b>

a. See [Chapter 13](#) for the requirements of this setting

b. This jumper setting requires the addition of components not populated on the standard configuration of the phyCORE-AM3517

## 4 Power

The phyCORE-AM3517 operates by using three separate power supply input domains. For systems that do not require the RTC, VBAT is not required and should be tied to ground.

The following sections of this chapter discuss the primary power pins on the phyCORE-Connector X2 in detail.

### 4.1 Primary System Power (VIN & VIN\_3V3)

The phyCORE-AM3517 operates from a primary voltage (VIN) supply with a nominal value of 3.3V - 5.0V DC. On-board switching regulators generate the 1.8V, 1.2V, and adjustable IO voltage VDDSHV. However an additional power supply of 3.3V is required to power the board. These two power supplies then generate all the required voltages of the AM3517 MCU and other on-board components.

For proper operation the phyCORE-AM3517 must be supplied with a voltage source of 3.3V - 5.0V at the VIN pins and 3.3V +/- 100mv on the VIN\_3V3 pins. 3.0V - 5.0V DC must be supplied at the VBAT pin if the RTC functionality is needed. See [Table 2-1](#) for VCC pin locations on phyCORE-Connector X2. See [Chapter 8.4](#) for current requirements.

It is possible to use a simplified power system to tie all supplies to a 3.3VDC source. VIN\_3V3 powers several peripheral chips on the SOM, but if these features are not required, then VIN\_3V3 can be connected to ground.

Connect all VIN and VIN\_3V3 input pins to your power supply and at least the matching number of GND pins neighboring the + VIN and VIN\_3V3 pins.

#### CAUTION:

As a general design rule we recommend connecting all GND pins neighboring signals which are being used in the application circuitry. For maximum EMI performance all GND pins should be connected to a solid ground plane.

### 4.2 Secondary Battery Power (VBAT)

For applications requiring a battery backed up RTC function, a battery supply with a nominal value of 3.0V is required. The battery supply powers the RTC during a power off condition, allowing primary system power (VIN) and VCC\_3V3 to be removed.

Applications not requiring a battery backed up RTC function can tie VBAT to ground.

### 4.3 PMIC Supplies (U2)

The PMIC located at U2 generates the 1.2V, 1.8V, VDDSHV (IO voltage), and two low power (1.8V and 3.3V) output supplies required by system components. This power is sourced from the primary VIN = 3.3V-5.0V. Various jumpers have been provided as current measurement access points on these supply outputs. [Table 4-1](#) provides a summary of the jumpers and their operation. See [Chapter 4.5](#) for current measurement techniques with a precision shunt resistor.

**Table 4-1. Current Measurements**

<b>R</b>	<b>Type</b>	<b>Setting</b>	<b>Description</b>
<b>R20</b>	0R	Open <b>Closed</b>	Reserved <b>VRTC to RTC IC (U22)</b>
<b>R21</b>	0R	Open <b>Closed</b>	Reserved <b>1.8V power to AM3517 (LDO output, low noise)</b>
<b>R22</b>	0R	Open <b>Closed</b>	Reserved <b>3.3V power to AM3517 (USB PHY)</b>
<b>R23</b>	0R	Open <b>Closed</b>	Reserved <b>1.8V power for AM3517 (U1) and other peripheral (SDRAM, USB, touch, NAND)</b>
<b>R24</b>	0R	Open <b>Closed</b>	Reserved <b>VDDSHV, IO power for AM3517 (U1) and all other peripheral</b>
<b>R25</b>	0R	Open <b>Closed</b>	Reserved <b>1.2V power to AM3517 (U1) and Ethernet PHY (U12)</b>

#### 4.4 RTC Supplies (U2)

The TPS65023 PMIC has incorporated a dual input, priority-switched power supply. This generates the VCC\_RTC power required by the RTC integrated circuit U2. The priority switch draws power from the VIN\_3V3 if it is available, otherwise the power is drawn from VBAT. Power to VBAT is supplied from a battery (Li-ION) connected to the VBAT pins on the phyCORE-Connector X2. The battery switch is responsible for connecting VIN\_3V3 to the input of U2 during normal operating conditions (VIN\_3V3 is present) and connecting VBAT to the input of U2 during a power off condition. The switchover between VIN\_3V3 and VBAT is automatic. An output jumper has been provided as a current measurement access point for VRTC. [Table 4-1](#) provides a summary of the jumpers and their operation. See [Chapter 4.5](#) for current measurement techniques with a precision shunt resistor.

#### 4.5 Selecting Shunt Resistors for Current Measurements

To make current measurements, the 0 Ohm resistors populating the regulator output jumpers should be replaced by precision shunt resistors, allowing the current draw to be calculated from the voltage measurement taken across the shunt resistor. When selecting a shunt resistor it is desirable to select a resistor large enough to give a voltage measurement that is not overtaken by noise. However, a larger shunt resistor means a larger voltage drop across the shunt, resulting in a smaller output voltage to powered devices. The output voltage after the shunt should be kept above the reset threshold. If the shunt resistor is too large, the voltage at the output could be below the supervisor reset threshold and force the system into reset. A good starting place is a 0.025 Ohm precision shunt in a 0805 package.

#### 4.6 Voltage Supervisor (U2, U21)

The phyCORE-AM3517 is designed with two voltage supervision circuits which are intimately interconnected to provide a robust voltage supervision system. The purpose of this circuit is to ensure that power supplies to the various ICs on the SOM are provided correct voltages at all times.

The PMIC (U2) continuously monitors its integrated power supplies for any loss of regulation. If regulation is lost, the PMIC will pull the open drain output /INT of U2 low. See Texas Instrument TPS55023b datasheet (page 25) for details.

The voltage supervision chip U21 has two functions:

1. If the /INT signal is driven low then the voltage supervisor chip U21 will drive /RESET low
2. If the input voltage to VIN is below 2.93V, the voltage supervisor will assert /RESET, driving it low

The reset signal /RESET (sys\_nrespwrn pin at the AM3517) is the main reset for the SOM. The possible causes of reset are:

- PMIC (TPS65023b) pin /RESPWRON: This output is an open drain, which can drive the /RESET signal low or hold it low at power up.

**NOTE:**

The PMIC will hold the signal low at power up for an additional second after the power supplies are stable. This additional second is provided by the system to ensure that the crystal oscillators are stable before the reset is released. In addition, the /HOT\_RESET signal can also drive the /RESET signal low.

- The voltage supervisor U21: This has two possible causes as already mentioned in [Chapter 4.6](#). When these reset causes clear, the U21 voltage supervisor holds reset low for an additional 200ms. This difference in time can be used to narrow down the causes of a reset event should debugging in the general area be required.
- The Carrier Board can generate a reset from the /RESET signal connected to the phyCORE-Connector X2. U21 senses this reset and adds a delay of 200ms.
- The /RESIN signal from the phyCORE-Connector X2 can cause the /RESET signal to be driven low as mentioned above. This signal is intended to be the standard method of issuing a reset to the SOM. U21 senses this reset and adds a delay of 200ms.

## 5 External RTC (U22)

The external RTC (RTC-8564JE) is located at U22. It provides a time keeping source and an alarm output to the AM3517 and phyCORE-Connector X2 via the /RTC\_INT signal (at GPMC\_NCS5).

The RTC is interfaced to the processor via the I<sup>2</sup>C1 port. The default I<sup>2</sup>C address of the device is binary 1010 001x, where the 'x' bit is the read/write operation bit.

The RTC is automatically powered via the VBAT power input during a power down.

The open collector output signal /RTC\_INT is provided to drive an external power wake circuit (not provided on the SOM) which would allow the system a signal to wake from sleep at some later time.

## 6 System Configuration and Booting

The phyCORE-AM3517 boots from an internal ROM which implements a boot order as described in section 24.2.3 - “Boot Configuration” of the AM3517 (TRM) Technical Reference Manual (page 2686; July 2010 revised edition). The phyCORE-AM3517 provides the SYS\_BOOT[0-6] pins at phyCORE-Connector X2 such that the users can hard configure the boot sequence. By default, the boot configuration is set to 0x01100 with SYS\_BOOT[5] set low so the boot sequence is NAND - EMAC - USB - MMC1. This can be changed to any of the TRM described sequences by tying SYS\_BOOT pins on the user’s application board or the PHYTEC carrier board.

The SYS\_BOOT pins are sampled at system reset. Boot speed can be increased by ensuring that the normal boot device of a production system is configured for the first priority device. The ROM in the AM3517 implements the boot sequence by accessing each peripheral at boot time and searching for a valid image. If a valid image exists, then the processor will boot to it. If an image is not valid, it will proceed to the next peripheral in the list.

**Table 6-1. Peripheral Booting Configuration Pins after POR**

sys_boot [5:0]	Boot Sequence: Peripheral Booting Preferred Order			
	First	Second	Third	Fourth
0b000001	NAND	EMAC	USB	
0b000011	MMC2	EMAC	USB	
0b000101	MMC2	USB		
0b000110	MMC1	USB		
0b000111	XIP	EMAC	USB	
0b001000	XDOC	EMAC	USB	
0b001001	MMC2	EMAC	USB	
0b001010	XIP	EMAC	USB	MMC1
0b001011	XDOC	EMAC	USB	MMC1
0b01100	NAND	EMAC	USB	MMC1
0b001101	XIP	USB	UART	MMC1
0b01110	XDOC	USB	UART	MMC1
0b001111	NAND	USB	UART	MMC1
0b010001	MMC2	USB	UART	MMC1
0b010010	MMC1	USB	UART	
0b010011	XIP	UART		
0b010100	XDOC	UART		
0b010101	NAND	UART		
0b010111	MMC2	UART		
0b011000	MMC1	UART		
0b011001	XIP	USB		
0b011010	XDOC	USB		
0b011011	NAND	USB		
0b011100	SPI	UART		

**Table 6-1. Peripheral Booting Configuration Pins after POR**

<b>sys_boot [5:0]</b>	<b>Booting Sequence: Peripheral Booting Preferred Order</b>			
0b011111	Fast XIP booting wait monitoring	USB	UART3	
0b100001	EMAC	USB	NAND	
0b100011	EMAC	USB	MMC1	MMC2
0b100101	USB	MMC2		
0b100110	USB	MMC1		
0b100111	EMAC	USB	XIP	
0b101000	USB	XDOC		
0b101001	EMAC	USB	MMC2	
0b101010	EMAC	USB	MMC1	XIP
0b101011	EMAC	USB	MMC1	XDOC
0b11100	EMAC	USB	MMC1	NAND
0b101101	USB	UART	MMC1	XIP
0b111110	USB	UART	MMC1	XDOC
0b101111	USB	UART	MMC1	NAND
0b110001	USB	UART	MMC1	MMC2
0b110010	USB	UART	MMC1	
0b110011	UART	XIP		
0b110100	UART	XDOC		
0b110101	UART	NAND		
0b110111	UART	MMC2		
0b111000	UART	MMC1		
0b111001	USB	XIP		
0b111010	USB	XDOC		
0b111011	USB	NAND		
0b111100	UART	SPI		
0b111111	Fast XIP booting wait monitoring	USB	UART3	

**Table 6-2. Booting Configuration Pins after a Warm Reset**

<b>sys_boot[5:0]</b>	<b>Booting Sequence: Memory Booting Preferred Order</b>	
	First	Second
0b000001	NAND	
0b000011	MMC2	
0b000101	MMC2	
0b000110	MMC1	



**Table 6-2. Booting Configuration Pins after a Warm Reset**

<b>sys_boot[5:0]</b>	<b>Booting Sequence: Memory Booting Preferred Order</b>	
0b000111	XIP	
0b001000	XIPwait	DOC
0b001001	MMC2	
0b001010	XIP	
0b001011	XIPwait	DOC
0b001100	NAND	
0b001101	XIP	
0b001110	XIPwait	DOC
0b001111	NAND	
0b010001	MMC2	
0b010010	MMC1	
0b010011	XIP	
0b010100	XIPwait	DOC
0b010101	NAND	
0b010111	MMC2	
0b011000	MMC1	
0b011001	XIP	
0b011010	XIPwait	DOC
0b011011	NAND	
0b011100	SPI	
0b011111	ROM code fast XIP booting	
0b100001	NAND	
0b100011	MMC2	
0b100101	MMC2	
0b100110	MMC1	
0b100111	XIP	
0b101000	XIPwait	DOC
0b101001	MMC2	
0b101010	XIP	
0b101011	XIPwait	DOC
0b101100	NAND	
0b101101	USB	XIP
0b101110	XIPwait	DOC
0b101111	NAND	
0b110001	MMC2	
0b110010	MMC1	
0b110011	XIP	
0b110100	XIPwait	DOC

**Table 6-2. Booting Configuration Pins after a Warm Reset**

<b>sys_boot[5:0]</b>	<b>Booting Sequence: Memory Booting Preferred Order</b>	
0b110101	NAND	
0b110111	MMC2	
0b111000	MMC1	
0b111001	XIP	
0b111010	XIPwait	DOC
0b111011	NAND	
0b111100	SPI	
0b111111	ROM code fast XIP booting	

## 6.1 Boot Process

The AM3517's ROM code looks for X-loader as the first image to continue the boot process. X-loader is an open-source program, maintained by Texas Instruments. X-loader configures the SDRAM, loads the next boot image, and then runs it. Unlike boot ROM, X-loader does not have a complex algorithm to search for the next image and must be hard-coded in the software. In order to execute the next boot loader (U-Boot or E-Boot), X-loader uses the SYS\_BOOT settings to determine which image to load. If desired, increasingly complex boot sequences are possible with modifications to the X-loader source code. However, one must carefully consider the TRM boot sequence, boot time, and reliability before making such changes.

## 7 System Memory

The phyCORE-AM3517 provides three types of on-board memory:

1. DDR2 SDRAM (U8/U9): from 256MB to 512MB (2x 128MB or 2x 256MB ICs)
2. NAND Flash (U16): from 128MB to 512MB
3. EEPROM (U13): from 256KB
- 4.

The following sections of this chapter detail each memory type used on the phyCORE-AM3517 SOM.

### 7.1 SDRAM (U8, U9)

The phyCORE-AM3517 is populated with either 256MB or 512MB of 333MHz DDR2 SDRAM configured for 32-bit access using two 16-bit wide RAM chips at U8 and U9.

The AM3517 is capable of addressing 8 RAM banks located at memory address 0x8000 0000. Refer to [Table 7-1](#) for permissible SDRAM memory access ranges.

**Table 7-1. Valid SDRAM Memory Address Ranges**

<b>SDRAM Size</b>	<b>Lower Memory Address</b>	<b>Upper Memory Address</b>
256MB	0x8000 0000	0x8FFF FFFF
512MB	0x8000 0000	0x9FFF FFFF

### 7.2 NAND Flash (U16)

The NAND memory is comprised of a single 128MB, 256MB or 512MB chip located at U16 and is interfaced via the AM3517 GPMC memory bus.

Write protection control of the NAND device is configurable via jumper J11. [Table 7-2](#) lists the various NAND Flash write protection control options, including the default setting on the standard version of the phyCORE-AM3517 SOM included in the Rapid Development Kits (RDK). See below for an overview from the Micron MT29F2G16 datasheet for "Block Lock" and the operation of the LOCK. Refer to this datasheet for information on unlock commands if the LOCK jumper is put in place to protect the NAND flash. Additionally the "LOCK TIGHT" feature of the NAND flash may be useful in some applications.

The block lock feature protects either the entire device or ranges of blocks from being programmed and erased. Using the block lock feature is preferable to using WP# to prevent PROGRAM and ERASE operations.

Block lock is enabled and disabled at power-on through the LOCK pin. At power-on, if LOCK is LOW, all BLOCK LOCK commands are disabled. However if LOCK is HIGH at power-on, the BLOCK LOCK commands are enabled. In addition to this, all the blocks on the device are protected or locked from PROGRAM and ERASE operations, even if WP# is HIGH. Before the contents of the device can be modified, the device must first be unlocked. Either a range of blocks or the entire device may be unlocked. PROGRAM and ERASE operations complete successfully only in the block ranges that have been unlocked. Blocks, once unlocked, can be locked again to protect them from further PROGRAM and ERASE operations.

"Blocks that are locked can be protected further, or locked tight. When locked tight, the device's blocks can no longer be locked or unlocked until the device is power cycled."<sup>1</sup>

Refer to [Table 7-2](#) for J11, LOCK pin jumper settings.

**Table 7-2. LOCK Pin Jumper Settings**

J	Type	Setting	Description
J11	0R	1+2	<b>At power on, LOCK is low and all "BLOCK LOCK " commands are disabled.</b>
		2+3	"BLOCK LOCK" commands are enabled and all blocks are locked at power up. Block unlock commands are required to unlock blocks prior to writing.

### 7.3 EEPROM (U13)

The phyCORE-AM3517 is populated with one 256KB EEPROM device. The EEPROM is not pre-programmed, so it can be used to store manufacturing information, Ethernet MAC ID, and/or other data. The EEPROM is an I<sup>2</sup>C device, connected to the I<sup>2</sup>C1 bus.

### 7.4 Memory Map

The phyCORE-AM3517 memory map is summarized in [Table 7-3](#) below. Make note of the memory addresses assigned to functions on the phyCORE-AM3517. A detailed memory map for the AM3517 can be found in the AM3517 TRM in section 2.2.

**Table 7-3. phyCORE-AM3517 Memory Map**

Start Address	End Address	Function
0x0000 0000	0x3FFF FFFF	General Purpose Memory Controller (GPMC 8/16 bit)
0x4000 0000	0x47FF FFFF	AM3517 internal memory
0x4800 0000	0x4FFF FFFF	AM3517 L4 internal interconnect
0x5000 0000	0x53FF FFFF	AM3517 Graphics Accelerator
0x5400 0000	0x57FF FFFF	AM3517 L4 Emulation
0x5800 0000	0x5BFF FFFF	Reserved
0x5C00 0000	0x5FFF FFFF	IPSS
0x6000 0000	0x67FF FFFF	Reserved
0x6800 0000	0x6DFF FFFF	AM3517 L3 internal interconnect
0x6E00 0000	0x6EFF FFFF	GPMC configuration registers
0x6F00 0000	0x6FFF FFFF	Reserved
0x7000 0000	0x7FFF FFFF	EMIF4-SMS virtual address space 0
0x8000 0000	0x9FFF FFFF	DDR2 SDRAM (512MB)
0xA000 0000	0xDFFF FFFF	Reserved
0xE000 0000	0xFFFF FFFF	EMIF4-SMS virtual address space 1

1. Micron MT29F2G16 Datasheet. Rev. D; Sept. 2009, pg.63

## 8 Serial Interfaces

The phyCORE-AM3517 provides on-board transceivers for four serial interfaces:

1. A high speed RS-232 transceiver supporting 920kbps on UART3
2. A high speed USB OTG transceiver internal to the AM3517 (USB0)
3. An external high speed USB Host port transceiver supporting AM3517 host port 1
4. An Auto-MDIX enabled 10/100 Ethernet PHY supporting the AM3517 Ethernet MAC

The following sections of this chapter detail each of these serial interfaces and any applicable configuration jumpers.

### 8.1 RS-232 Transceiver (U15)

A TRSF3221E RS-232 transceiver supporting typical data rates of 115.2kbps populates the phyCORE-AM3517 at U15. This device provides RS-232 level translation for UART3 of the AM3517. [Table 8-1](#) details the TTL and RS-232 level signals for UART3. See the pin description listing in [Chapter 2, Table 2-1](#) for the signal locations on the phyCORE-Connector X2.

For custom configurations which do not require RS-232 level translation, the RS-232 transceiver (U15) can be removed and 0 Ohm resistors J14 and J15 can be populated. In this configuration there is a direct short between the TTL level signal name and RS-232 level signal name, leaving the RS-232 level signal names operating at TTL levels.

**Table 8-1. UART3 TTL and RS-232 Level Signals**

UART	TTL Level Signal Name	RS-232 Level Signal name
UART3	UART3_TX	UART3_TX_RS232
	UART3_RX	UART3_RX_RS232
	UART3_CTS	
	UART3_RTS	

### 8.2 Ethernet PHY (U12)

The phyCORE-AM3517 comes populated with an SMSC LAN8720I Ethernet PHY at U12 supporting 10/100 Mbps Ethernet connectivity. The PHY uses an RMII interface to the Ethernet MAC integrated on the AM3517.

The LAN8720I supports the HP Auto-MDIX function eliminating the need for consideration of a direct connect LAN cable, or a cross-over patch cable. The LAN8720I detects the TX and RX pins of the connected device and automatically configures the PHY TX and RX pins accordingly. Interfacing the Ethernet port involves incorporating RJ45 and appropriate magnetic devices into your design. Please consult the phyCORE-AM3517 Carrier Board schematics as a reference. Impedance matching and careful layout practices are important for signal integrity, particularly where long cable lengths need to be supported in the target application.

### 8.3 USB OTG (U1)

The phyCORE AM3517 comes with a USB On-The-Go transceiver internal to AM3517 that supports both full speed and low speed data rates. This USB port can be configured as a dedicated host, dedicated peripheral, or OTG interface.

When designing the USB interface, pay special attention to current requirements when operating as an embedded host. By default an embedded USB OTG host only needs to supply 8mA of current to a connecting peripheral. However, the AM3517 is not capable of supplying this current to a connecting peripheral, so a device on the carrier board is required to satisfy this requirement. To meet this higher current requirement the USB0\_DRVVBUS pin can be used. This signal can drive an external power control switch capable of sourcing additional power. In this configuration the USB0\_DRVVBUS signal is connected to the power supply enable input pin and the USB\_VBUS signal is sourced from a 5V power supply output. See the phyCORE-AM3517 Carrier Board schematics for reference circuitry that makes use of the USB0\_DRVVBUS pin to provide additional host current.

Termination for the USB0 signals are internal to the AM3517. A USB\_VBUS capacitor of 4.7 $\mu$ F has been placed on the phyCORE-AM3517 Carrier Board. It should be noted that the maximum VBUS capacitance a USB OTG device can add to the bus is 6.5 $\mu$ F. Therefore, adding anything more than 1.7 $\mu$ F external to the phyCORE-AM3517 on USB\_VBUS is not recommended when operating in OTG mode. This may be increased to the typical 120 $\mu$ F minimum required by the USB specifications for dedicated host devices if OTG mode is not required.

In addition to optional power control circuitry via the USB\_DRVVBUS signal, an external USB connector is all that is needed to interface the phyCORE-AM3517 USB functionality. [Table 8-2](#) details applicable connectors for various end-application operating modes. The applicable interface signals (USB\_DM/USB\_DP/USB\_VBUS/USB\_ID/USB\_DRVVBUS) can be found in the phyCORE-Connector pin-out [Table 2-1](#) located in [Chapter 2](#).

**Table 8-2. Applicable USB Operating Mode Connectors**

Operating Mode	Applicable Connectors
Host	Standard-A
	Mini-A
Device/Peripheral	Standard-B
	Mini-B
OTG	Mini-AB

## 8.4 USB1 Host (U1, U7)

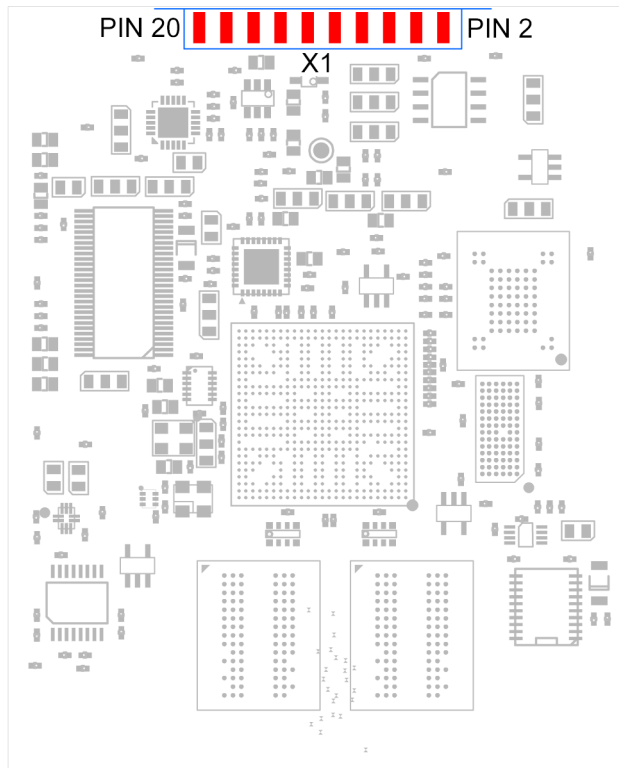
In addition to the USB OTG signals, the phyCORE-AM3517 also provides a USB 3320 Host transceiver connected to the AM3517 Host controller. This USB interface supports high, full, and low speed data rates.

When designing the USB host interface, pay special attention to the necessary current requirements as an embedded host. The AM3517 is not capable of supplying this current to a connecting peripheral, so a device is required on the carrier board to satisfy this requirement. To meet this higher current requirement the USB1\_CPEN pin can be used. This signal can drive an external power control switch capable of sourcing additional power. In this configuration, the USB1\_CPEN signal is connected to the power supply enable input pin and the USB\_VBUS signal is sourced from a 5V power supply output. See the phyCORE-AM3517 Carrier Board schematics for reference circuitry that makes use of the USB1\_CPEN pin to provide additional host current.

Termination for the USB1 signals are internal to the USB3320. A USB\_VBUS capacitor of 150 $\mu$ F has been placed on the phyCORE-AM3517 Carrier Board. In addition to optional power control circuitry via the USB1\_CPEN signal, an external USB connector is all that is needed to interface the phyCORE-AM3517 USB functionality. [Table 8-2](#) details applicable connectors for various end application operating modes. The applicable interface signals (USB\_DM/USB\_DP/USB\_VBUS/USB\_ID/USB\_DRVVBUS) can be found in the phyCORE-Connector pin-out [Table 2-1](#) located in [Chapter 2](#).

## 9 Debug Interface (X1)

The phyCORE-AM3517 is equipped with a JTAG interface for downloading program code into the internal RAM controller or for debugging programs currently executing. In addition to being made available at the phyCORE-Connector X2, the JTAG interface extends out to a 2.54 mm pitch pin header at X1 on the edge of the module. [Figure 9-1](#) shows the position of the debug interface (JTAG connector X1) on the phyCORE-AM3517. Even numbered pins are on the top of the module, moving from pin 2 on the right to pin 20 on the left. Odd number pins are on the bottom, starting from (as viewed from the top) 1 on the right to 19 on the left.



**Fig. 9-1. JTAG Interface X1 (Controller Side)**

The JTAG edge card connector X1 provides an easy means of debugging the phyCORE-AM3517 in your target system via an external JTAG probe, such as RealView ICE.

**NOTE:**

The JTAG connector X1 only populates phyCORE-AM3517 modules with order code PCM-048-xxxxxD. This version of the phyCORE module must be special ordered. The JTAG connector X1 is not populated on phyCORE modules included in the Rapid Development Kits. All JTAG signals are accessible from the Carrier Board and at the phyCORE-Connector X2 on the SOM. Integration of a standard (2.54 mm pitch) pin header connector in the user target circuitry is recommended to allow easy program updates via the JTAG interface. See [Chapter 2](#) for details on the JTAG signal pin assignment.

## **10 Touch Screen Controller (U25)**

The phyCORE-AM3517 SOM provides an on-board touch controller (TSC2004). The touch controller interfaces with a resistive touch panel typically integrated into an LCD. The touch screen controller communicates with the AM3517 over I<sup>2</sup>C1 at address 1001001x (by default). The touch sense signals (X+, X-, Y+, Y) are routed to the phyCORE-Connector X2 for connection to an external resistive touch panel. Care should be taken to route the touch panel sense signals to achieve low noise.



## 11 LCD LVDS Transmitter

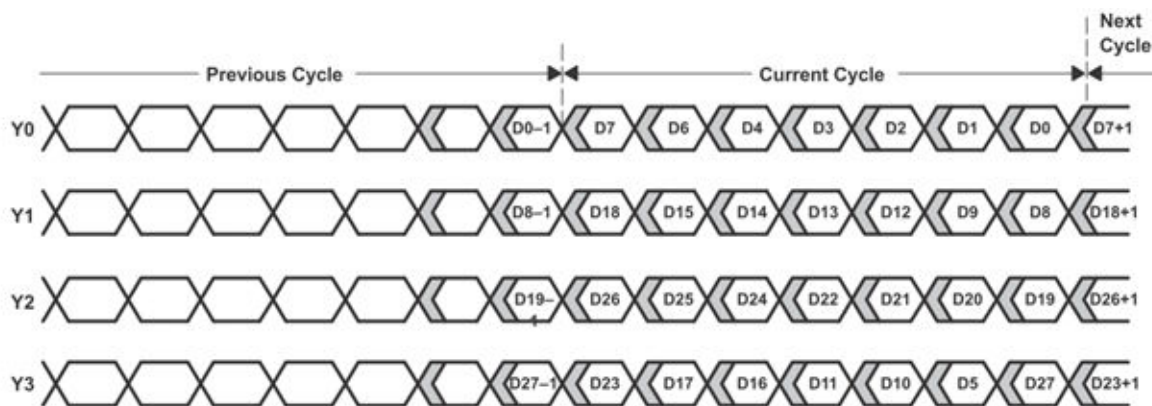
The phyCORE-AM3517 provides an LVDS transmitter for use in conjunction with a compatible LVDS LCD panel. The LVDS transmitter is connected to the processor's display subsystem interface (DSS); providing 24-bits of color data in addition to control signals.

There are several advantages of the LVDS LCD interface over its TTL counterpart. Some of those advantages include:

- The differential nature of the signals decreases susceptibility to EMI
- The differential nature of the signals decreases the magnitude of radiated emissions
- Differential signals allow longer trace, and/or cable lengths
- I/O signal count is lower due to time division multiplexing of the signals at a high bit rate (28 signals are reduced to 10 signals)

It should be noted that not all LVDS transmitters and LVDS LCD panels are compatible. Ensure that the time division multiplexing (TDM) used by the LVDS transmitter on the phyCORE-AM3517 is compatible with the TDM scheme in the LVDS receiver used in the LCD panel of interest. To elaborate on this note, a basic theory of operation in conjunction with the phyCORE-AM3517 LVDS circuit is presented below.

The LVDS transmitter operates by serializing the parallel data from the display subsystem interface and transmitting this serialized data at a high frequency over a set of 5 differential pairs (one pair dedicated to differential clock). This technique is a form of time division multiplexing (TDM) where a large set of several control and color data signals are multiplexed in time over a smaller set of differential signals. [Figure 11-1](#)<sup>1</sup> below shows the multiplexing scheme used by the LVDS transmitters used on the phyCORE-AM3517 (SN65LVDS93 and SN75LVDS83B depending on IO voltage configuration).



**Fig. 11-1. LVDS Multiplexing Scheme**<sup>1</sup>

To illustrate an example, take the DSS\_DATA23 signal from the processor. This signal is normally bit 7 of the red color channel when operating in 24-bit mode. DSS\_DATA23 is connected to the LVDS transmitter D6 input pin. From [Figure 11-1](#) above, that means the DSS\_DATA23 signal shows up as the 6th bit in differential data channel Y0 (signals LCD\_LVDS\_Y1P & LCD\_LVDS\_Y1M on the phyCORE-AM3517) in time. Thus, when determining if a particular LCD LVDS receiver is compatible with the phyCORE-AM3517, the red bit 7 of the LVDS receiver should be expected on differential channel 0 at bit position 6. This type of analysis should be done for all color and control bits connected to the LVDS transmitter on the phyCORE-AM3517 to ensure compatibility.

1. Texas Instruments SN64LVDS93 datasheet; figure 1

## 11.1 LVDS and SOM I/O Voltage (J23)

The phyCORE-AM3517 was designed to support a configurable bus operating voltage of 1.8V or 3.3V (see chapter [Chapter 13](#) for details). To support this dual mode configuration, different LVDS transmitters must be used at different bus voltage levels. When running at 3.3V (the standard configuration) the SN65LVDS93 is used. When running at 1.8V the SN75LVDS83B is used. Although the SN75LVDS83B can operate at both 1.8V and 3.3V while the SN65LVDS93 cannot (3.3V only), the SN75LVDS83B is limited to an operating temperature of -10C to +70C, while the SN65LVDS93 is capable of -40C to +85C. Thus the following becomes true:

- Designs requiring LVDS and industrial temperature (-40C to +85C) ratings must operate at 3.3V and use the SN65LVDS93
- Designs requiring LVDS and 1.8V operating voltage will not be rated for industrial temperature range and must use the SN75LVDS83B

To accommodate these two different LVDS transmitter parts with different power requirements, jumper J23 is provided. When the SN65LVDS93 is populating the board, jumper J23 should be set to 1+2. When the SN75LVDS83B is populating the board, jumper J23 should be set to 2+3. If the SOM is being configured for 1.8V operation and one is attempting to replace the SN65LVDS93 with the SN75LVDS83B on the standard kit version of the SOM by hand, make sure all of the modifications listed in [Chapter 13](#) are implemented to avoid damaging the SOM or Carrier Board before powering up the system.

### **CAUTION:**

The SN75LVDS83B has its own unique data sheet and should not be confused with the similar part # SN75LVDS83

## 12 General Purpose Memory Controller (U2)

The phyCORE-AM3517 provides a configurable voltage GPMC interface for the connection of external memory mapped peripherals. Data bus direction is controlled by the processor's output enable signal /OE. [Table 12-1](#) provides a detailed list of the memory bus signals available at the phyCORE-Connector X2. Refer to the phyCORE-Connector pin-out [Table 2-1](#) for signal locations.

**Table 12-1. GPMC Signal Mapping**

General Purpose Signal	phyCORE Signal Name
Address line A0 - A10	GPMC_A0 - A10
Data lines D0 - D15	GPMC_D0 - 15
Chip Selects 1 - 7	GPMC_NCS1 - 7
External wait signal to GPMC interface	GPMC_WAIT0 - 3
Upper byte enable / command latch enable	GPMC_NBE0_CLE
Lower byte enable	GPMC_NBE1
Write protect	GPMC_NWP
Output enable (to slaves)	GPMC_NOE
Clock	xGPMC_CLK
Write enable	xGPMC_NWE
Address valid / Address latch enable	xGPMC_NADV_ALE

See section 9.1.6.2.2 of the AM3517 TRM for GPMC interface and section 9.1.7.2.1 for GPMC interface configuration/register descriptions. The GPMC\_NCS1-7 signals are programmable throughout the memory space 0x0000 0000 to 0x3FFF FFFF as noted in the memory maps with few limitations. This flexible controller should provide an easily configured interface to NOR Flash, FPGAs, and many other general purpose bus interface required ICs.

## 13 AM3517 IO and GPMC Bus Voltage

The buffered memory bus operating voltage is configurable at 1.8V or 3.3V via jumper J8 to allow connection to a variety of devices. By default this jumper is set to the 2+3 position, selecting 3.3V. To interface 1.8V low power devices to the external memory bus, J8 should be set to the 1+2 position. Switching to 1.8V IO will reduce the power consumption of the embedded system.

**WARNING:**

Normal operating voltage for the Carrier Board and SOM is 3.3V.

In 3.3V IO mode the following is required:

- Carrier Board X21 set to 3+5 and 4+6
- Carrier Board JP13 set to OPEN
- SOM J8 set to 2+3
- SOM U3 SN65LVDS93 optionally installed
- SOM J23 set to 1+2

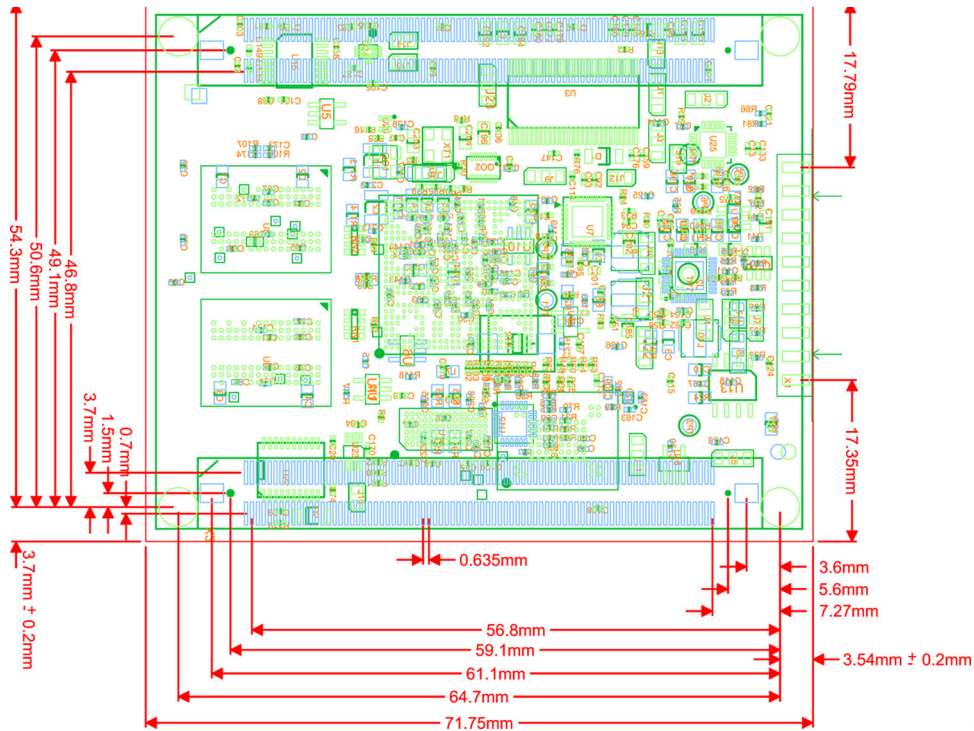
In 1.8V IO mode the following is required:

- Carrier Board X21 set to 1+3 and 2+4
- Carrier Board JP13 set to CLOSED
- SOM J8 set to 1+2
- SOM U3 SN75LVDS83B optionally installed
- SOM J23 set to 2+3

Failure to follow these guidelines will result in damage to the SOM and Carrier Board circuitry.

## 14 Technical Specifications

The physical dimensions of the phyCORE-AM3517 are represented in [Figure 14-1](#). The module's profile is approximately 6.7mm thick. The maximum component height is approximately 4.5mm on the bottom (connector) side of the PCB and approximately 2.58mm on the top (microcontroller) side. The board itself is approximately 1.55mm thick. The distance from the Carrier board surface to the highest component on the top side of the board is approximately 8mm.



**Fig. 14-1.** phyCORE-AM3517 Physical Dimensions

**Table 14-1.** Technical Specifications

Dimensions	72 x 58 mm
Weight	TBD
Storage Temperature	-40C to +90C
Operating Temperature	-40C to +85C
Humidity	95% r.F. not condensed
Power Consumption	~1.25W typical <b>Operating Conditions:</b> VIN = 3.3V 256MB SDRAM @ 333MHz, 256MB NAND, Linux booted

**Table 14-2. Static Operating Characteristics<sup>a</sup>**

Symbol	Description	Conditions	Min	Type	Max	Unit
VIN	Primary SOM input voltage		3.0	3.3	5.0	VDC
VIN_3V3	Peripheral device power (USB, Enet, RTC, RS-232)		3.0	3.3	3.6	
VBAT	Battery backup for RTC		2.73	3.3	3.75	
I <sub>VIN</sub>	Primary SOM operating current	Core @ 600MHz, 256MB SDRAM @ 333MHz, 256MB NAND, Linux Booted, Ethernet Linked		338.2		mA
I <sub>VIN_3V3</sub>	Peripheral device current (USB, Enet, RTC, RS-232)	Core @ 600MHz, 256MB SDRAM @ 333MHz, 256MB NAND, Linux Booted, Ethernet Linked		72.8		mA
I <sub>VBAT</sub>				TBD		mA

a. Tamb = -40C to +85C unless otherwise specified.

These specifications describe the standard configuration of the phyCORE-AM3517 as of the printing of this manual.

## **15 Hints for Handling the phyCORE-AM3517**

Removal of various components, such as the microcontroller and the standard quartz, is not advisable given the compact nature of the module. Should this nonetheless be necessary, please ensure that the board, as well as surrounding components and sockets, remain undamaged while de-soldering. Overheating the board can cause the solder pads to loosen, rendering the module inoperable. Carefully heat neighboring connections in pairs. After a few alternations, components can be removed with the solder-iron tip. Alternatively, a hot air gun can be used to heat and loosen the bonds.

---

## **Part II: PCM-961/phyCORE-AM3517 Carrier Board**

---

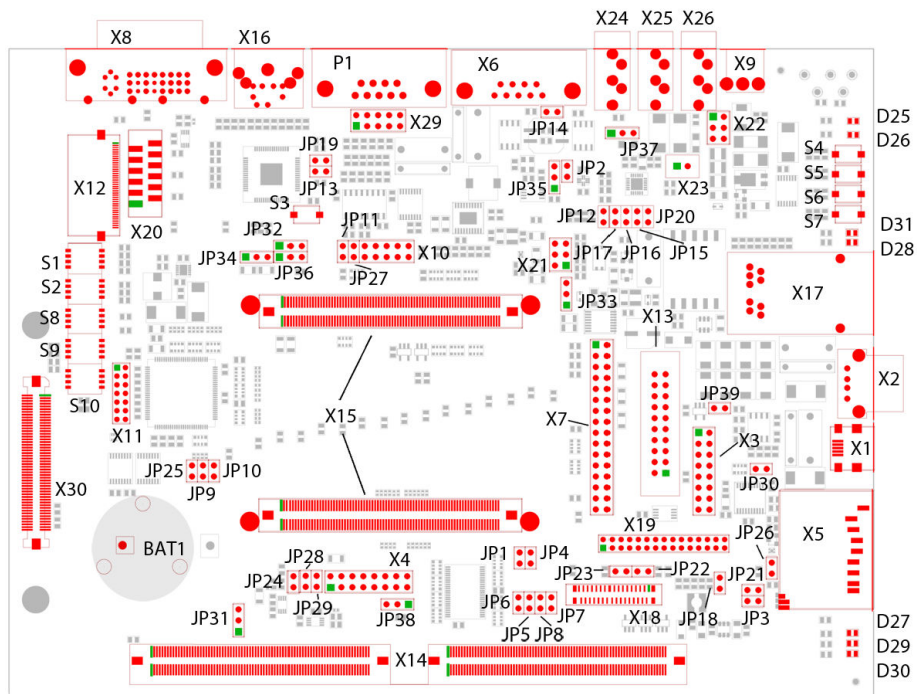
Part 2 of this three part manual provides detailed information on the phyCORE-AM3517 Carrier Board and its usage with the phyCORE-AM3517 SOM.

The information in the following chapters is applicable to the 1336.1 PCB revision of the phyCORE-AM3517 Carrier Board. All board images in this section of the manual refer to the 1336.1 PCB.

The Carrier Board can also serve as a reference design for development of custom target hardware in which the phyCORE SOM is deployed. Carrier Board schematics with BoM are available under a Non Disclosure Agreement (NDA). Re-use of Carrier Board circuitry likewise enables users of PHYTEC SOMs to shorten time-to-market, reduce development costs, and avoid substantial design issues and risks.



## 16 Introduction

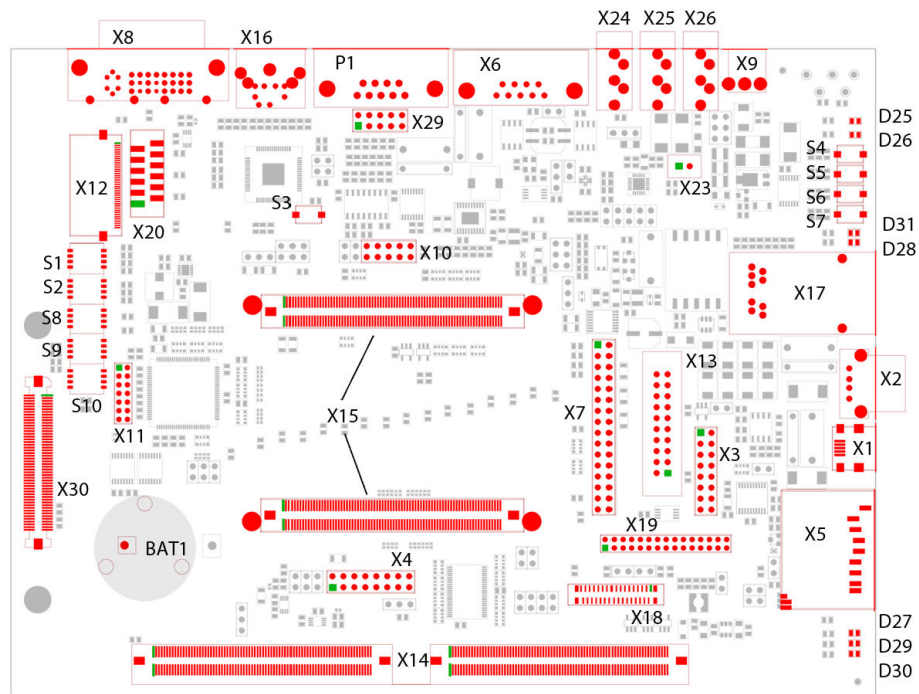


**Fig. 16-1. phyCORE-AM3517 Carrier Board**

PHYTEC Carrier Boards are fully equipped with all mechanical and electrical components necessary for a speedy, secure start-up and subsequent communication to, and programming of, the applicable PHYTEC System on Module (SOM). Carrier Boards are designed for evaluation, testing, and prototyping of PHYTEC SOMs in laboratory environments prior to their use in customer designed applications.

The phyCORE-AM3517 Carrier Board provides a flexible development platform enabling quick and easy start-up and subsequent programming of the phyCORE-AM3517 System on Module. The Carrier Board design allows easy connection of additional expansion boards featuring various functions that support fast and convenient prototyping and software evaluation.

## 17 Overview of Peripherals



**Fig. 17-1. Overview of Peripherals**

The phyCORE-AM3517 Carrier Board is depicted in [Figure 17-1](#) and includes the following components and peripherals listed in [Table 17-1](#), [Table 17-2](#), and [Table 17-3](#). For a more detailed description of each peripheral, refer to the appropriate chapter listed in the applicable table.

**Table 17-1. Connectors and Headers**

Ref. Des.	Description	Chapter
X1	USB OTG Connector (AM3517 - USB1)	<a href="#">24</a>
X2	USB Host (AM3517 - USB0)	<a href="#">24</a>
X3	MMC1 easy access header	<a href="#">28</a>
X4	Camera easy access header (AM3517 - CCDC)	<a href="#">32</a>
X5	MMC / SDIO connector (AM3517-MMC1)	<a href="#">28</a>
X6	CAN connector	<a href="#">32</a>
X7	WIFI connector (AM3517 - MCBSP1 / UART1 / MMC2)	<a href="#">30</a>
X8	DVI video connector	<a href="#">25</a>
X9	Wall adapter input power jack to supply main board power	<a href="#">20</a>
X10	UART easy access connector (AM3517 - UART2 / UART3)	<a href="#">27</a>
X11	CPLD JTAG (video bit map programmable logic)	<a href="#">21</a>
X12	LCD LVDS connector	<a href="#">25</a>
X13	JTAG interface to AM3517	<a href="#">21</a>
X14	GPIO expansion connectors	<a href="#">26</a>

**Table 17-1. Connectors and Headers (Continued)**

Ref. Des.	Description	Chapter
X15	phyCORE-AM3517 connectors to SOM	19
X16	TV Out	31
X17	Ethernet connector (POE capable)	20
X18	PHYTEC Camera interface (AM3517 - CCDC)	32
X19	PHYTEC Camera easy access header (AM3517 - CCDC)	32
X20	LVDS LCD power and backlight control connector	25
X23	Loudspeaker connector	22
X24	MIC in connector	22
X25	Headphones connector	22
X26	Line out	22
X27	Ground test point	N/A
X28	Ground test point	N/A
X29	UART2 RS-232 connector	27
X30	LCD TTL connector	25
P1	UART3 RS-232 connector	27

**Table 17-2. Description of the Buttons and Switches**

Ref. Des.	Description	Chapter
S1	LCD video color bit depth control	25
S2	LCD orientation control	25
S3	System Reset button	36
S4	User button 4 (labeled BTN4)	33
S5	User button 3 (labeled BTN3)	33
S6	User button 2 (labeled BTN2)	33
S7	User button 1 (labeled BTN1)	33
S8	SYS_BOOT 4 & 5 switches	35
S9	SYS_BOOT 3 & 2 switches	35
S10	SYS_BOOT 1 & 0 switches	35

**Table 17-3. Description of LEDs**

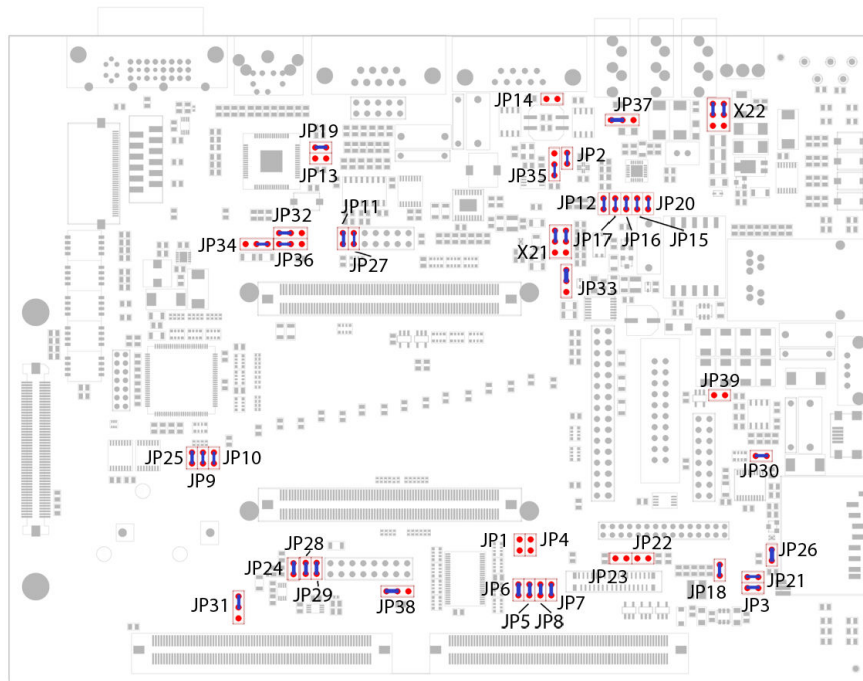
Ref. Des.	Description	Chapter
D25	PoE power available	20
D26	Power connector power available	20
D27	User controlled LED 2	34
D28	Ethernet Link LED	34

**Table 17-3. Description of LEDs (Continued)**

<b>Ref. Des.</b>	<b>Description</b>	<b>Chapter</b>
D29	User controlled LED 1	<a href="#">34</a>
D30	User controlled LED 3	<a href="#">34</a>
D31	Ethernet Speed LED	<a href="#">34</a>

Please note that all module connections are not to exceed their expressed maximum voltage or current. Maximum signal input values are indicated in the corresponding controller User's Manual/Data Sheets. As damage from improper connections varies according to use and application, it is the user's responsibility to take appropriate safety measures to ensure that the module connections are protected from overloading through connected peripherals.

## 18 Jumpers



**Fig. 18-1. Jumper Locations and Default Settings**

The phyCORE-AM3517 Carrier Board comes pre-configured with 39 removable jumpers (JP). The jumpers allow the user flexibility in rerouting a limited number of signals for development constraint purposes. [Table 18-1](#) below lists the 39 removable jumpers, their default positions, and their functions in each position. [Figure 18-2](#) depicts the jumper pad numbering scheme for reference when altering jumper settings on the development board. Note that pin 1 is always marked by a cut corner on the silk-screen on the PCB and with a green indicator in the jumper location diagrams that follow. [Figure 18-1](#) provides a detailed view of the phyCORE-AM3517 Carrier Board jumpers and their default settings.



**Fig. 18-2. Typical Jumper**

[Table 18-1](#) provides a comprehensive list of all Carrier Board jumpers. The table only provides a concise summary of jumper descriptions. For a detailed description of each jumper see the applicable chapter listing in the right hand column of the table.

The following conventions were used in the J/JP column of the jumper table:

- J = solder jumper
- JP = removable jumper

**Table 18-1. Jumper Settings**

<b>J/JP</b>	<b>Setting</b>	<b>Description</b>	<b>Chapter</b>
<b>X22</b>	<b>1+3, 2+4</b>	<b>Selects the X9 power connector for main power input (3.3-5.0V)</b>	<b>20</b>
	<b>3+5, 4+6</b>	Selects the PoE power supply	
<b>X21</b>	<b>1+3, 2+4</b>	Selects the SOM IO voltage to be 1.8V (this requires a SOM with 1.8V IO configuration)	<b>20</b>
	<b>3+5, 4+6</b>	<b>Selects the SOM IO voltage to be 3.3V (standard SOM)</b>	
<b>JP1</b>	<b>Open</b>	<b>JTAG_EMU1 - Normal operation</b>	<b>21</b>
	<b>Closed</b>	JTAG_EMU1 - See section 24.5.2 of the AM3517 TRM	
<b>JP2</b>	<b>Open</b>	Allows CAN_HECC1 signal to be used as GPIO_131 or UART3_RTS	<b>29</b>
	<b>Closed</b>	<b>CAN HECC1_RXD connected to CAN transceiver</b>	
<b>JP3</b>	<b>Open</b>	Allows xMMC1_DAT6 to be used as GPIO_128	<b>28</b>
	<b>Closed</b>	<b>xMMC1_DAT6 connected to SDIO write protect</b>	
<b>JP4</b>	<b>Open</b>	<b>JTAG_EMU1 - Normal operation</b>	<b>21</b>
	<b>Closed</b>	JTAG_EMU1 - See section 24.5.2 of the AM3517 TRM	
<b>JP5</b>	<b>Open</b>	Allows ETK_D11 to be used as GPIO_25 at expansion connector or other functions, see AM3517 TRM	<b>33</b>
	<b>Closed</b>	<b>Button 2 drives ETK_D11 signal</b>	
<b>JP6</b>	<b>Open</b>	Allows ETK_D12 to be used as GPIO_26 at expansion connector or other functions, see AM3517 TRM	<b>33</b>
	<b>Closed</b>	<b>Button 3 drives ETK_D12 signal</b>	
<b>JP7</b>	<b>Open</b>	Allows ETK_D10 to be used as GPIO_24 at expansion connector or other functions, see AM3517 TRM	<b>33</b>
	<b>Closed</b>	<b>Button 1 drives ETK_D10 signal</b>	
<b>JP8</b>	<b>Open</b>	Allows ETK_D13 to be used as GPIO_27 at expansion connector or other functions, see AM3517 TRM	<b>33</b>
	<b>Closed</b>	<b>Button 4 drives ETK_D13 signal</b>	
<b>JP9</b>	<b>Open</b>	Allows MCSPI1_CS3 to be used as GPIO_177 at expansion connector or other functions, see AM3517 TRM	<b>25</b>
	<b>Closed</b>	<b>MCSPI1_CS3 connected to LCD_SPI_IRQ on X12</b>	
<b>JP10</b>	<b>Open</b>	Allows MCSPI1_SOMI to be used as GPIO_173 at expansion connector or other functions, see AM3517 TRM	<b>25</b>
	<b>Closed</b>	<b>MCSPI1_SOMI connected to LCD_SPI_MISO on X12</b>	
<b>JP11</b>	<b>Open</b>	Allows UART2_RXD to be used as GPIO_147 at expansion connector or other functions, see AM3517 TRM	<b>27</b>
	<b>Closed</b>	<b>UART2_RXD connected to xUART_RX</b>	
<b>JP12</b>	<b>Open</b>	Allows MCBSP2_DR to be used as GPIO_118 at expansion connector or other functions, see AM3517 TRM	<b>22</b>
	<b>Closed</b>	<b>Connects MCBSP2_DR to audio codec</b>	
<b>JP13</b>	<b>Open</b>	<b>Sets the LCD LVDS transceiver IO reference for 3.3V</b>	<b>25</b>
	<b>Closed</b>	Sets the LCD LVDS transceiver IO reference for 1.8V	
<b>JP14</b>	<b>Open</b>	<b>Configures the Carrier Board as an intermediate node on the CAN network.</b>	<b>29</b>
	<b>Closed</b>	Provides termination impedance at the carrier board	
<b>JP15</b>	<b>Open</b>	Allows MCBSP2_CLKX to be used as GPIO_117 at expansion connector	<b>22</b>
	<b>Closed</b>	<b>Connects MCBSP2_CLKX to audio codec</b>	

**Table 18-1. Jumper Settings (Continued)**

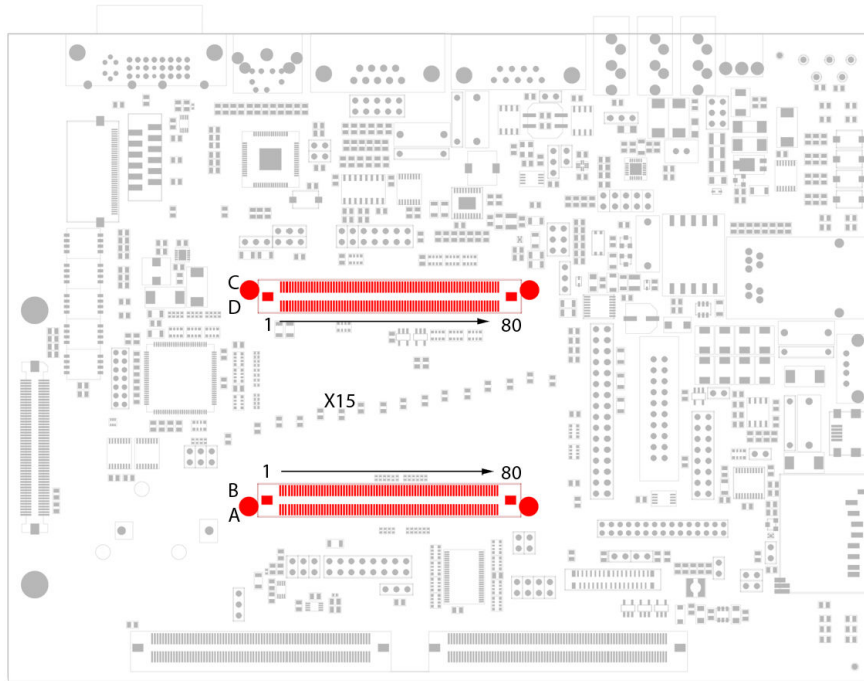
<b>J/JP</b>	<b>Setting</b>	<b>Description</b>	<b>Chapter</b>
<b>JP16</b>	Open	Allows MCBSP2_FSX to be used as GPIO_116 at expansion connector	22
	Closed	Connects MCBSP2_FSX to audio codec	
<b>JP17</b>	Open	Allows MCBSP2_DX to be used as GPIO_119 at expansion connector	22
	Closed	Connects MCBSP2_DX to audio codec	
<b>JP18</b>	Open	Disconnects camera power	32
	Closed	Connects camera power	
<b>JP19</b>	Open	Allows MCBSP4_FSX to be used as GPIO_155 or other functions, enable DVI transcoder	25
	Closed	Enables MCBSP4_FSX to control power down of DVI transcoder	
<b>JP20</b>	Open	Test point for GPIO from audio codec	22
	Closed	Reserved	
<b>JP21</b>	Open	Allows xMMC1_DAT7 to be used as GPIO_129	28
	Closed	xMMC1_DAT6 connected to SDIO card detect	
<b>JP22</b>	Open	See phyCAM-P interface manual for operation of this jumper	32
	Open		
<b>JP23</b>	Open	See phyCAM-P interface manual for operation of this jumper	32
	Open		
<b>JP24</b>	Open	Disconnects GPMC_NCS2 from LCD_PWM, disables LCD backlight intensity control, allows GPMC_NC2 to be used as GPIO_53 or other functions, see AM3517 TRM	25
	Closed	Enables ETK_D14 (gpt9_pwm_evt) to control LCD backlight intensity	
<b>JP25</b>	Open	Disconnects ETK_D14 from LCD_BL_EN, enables LCD back light, allows ETK_D14 to used as GPIO_28 or other functions, see AM3517 TRM	25
	Closed	Enables ETK_D14 (gpio_28) to control LCD backlight enable	
<b>JP26</b>	Open	Disconnects xMMC1_DAT5 from SDIO power enable, power enabled by card detect, SW can not turn power off to SDIO interface	28
	Closed	Enables MMC1_DAT5 (gpio_127) to power off to SDIO interface; saving power	
<b>JP27</b>	Open	Allows UART2_CTS to be used as GPIO_144 at expansion connector or other functions, see AM3517 TRM	27
	Closed	Connects UART2_CTS to xUART2_CTS	
<b>JP28</b>	Open	Allows GPMC_WAIT2 to be used as GPIO_64 at expansion connector or other functions, see AM3517 TRM	24
	Closed	Connects GPMC_WAIT2 to USB1 over current indication	
<b>JP29</b>	Open	Allows GPMC_WAIT3 to be used as GPIO_65 at expansion connector or other functions, see AM3517 TRM	24
	Closed	Connects GPMC_WAIT3 to USB0 over current indication	
<b>JP30</b>	Open	Sets USB0 capacitance on VBUS to 4uF for OTG mode	24
	Closed	Sets USB0 capacitance on VBUS to 150uF for host mode	
<b>JP31</b>	1+2	Grounds VBAT; RTC is not powered when main power is off	20
	2+3		
<b>JP32</b>	1+2	SYS_CLKOUT1 drives audio MCLK (through JP35)	22
	2+3	SYS_CLKOUT1 drives SYS_CLKOUT1B	

**Table 18-1. Jumper Settings (Continued)**

<b>J/JP</b>	<b>Setting</b>	<b>Description</b>	<b>Chapter</b>
<b>JP33</b>	1+2	Sets the reference (SIGDISA) to the PoE power supply to VPORTN	20
	2+3	<b>Sets the reference (SIGDISA) to the PoE power supply to VPORTP</b>	
<b>JP34</b>	1+2	Enables SOM VIN power to be driven from X22 (3.3V - 5.0V)	20
	2+3	<b>Enables SOM VIN power to be driven from Carrier Board 3.3V power supply</b>	
<b>JP35</b>	1+2	<b>Enables Audio MCLK to be driven from OZ1 crystal oscillator</b>	22
	2+3	Enables Audio MCLK to be driven from OZ1 AM3517 SYS_CLKOUT1 (through JP32)	
<b>JP36</b>	1+2	<b>Configures SYS_CLKOUT1 to drive CAM_MCLK</b>	32
	2+3	Configures SYS_CLKOUT1 to drive SYS_CLKOUT1B	
<b>JP37</b>	1+2	<b>Connects microphone bias to tip</b>	22
	2+3	Connects microphone bias to ring	
<b>JP38</b>	1+2	Disables the Camera input	32
	2+3	<b>Enables camera input</b>	
<b>JP39</b>	Open	<b>USB0 OTG ID pin pulled high, normal for OTG</b>	24
	Closed	USB0 OTG ID pin grounded, port set to host mode	



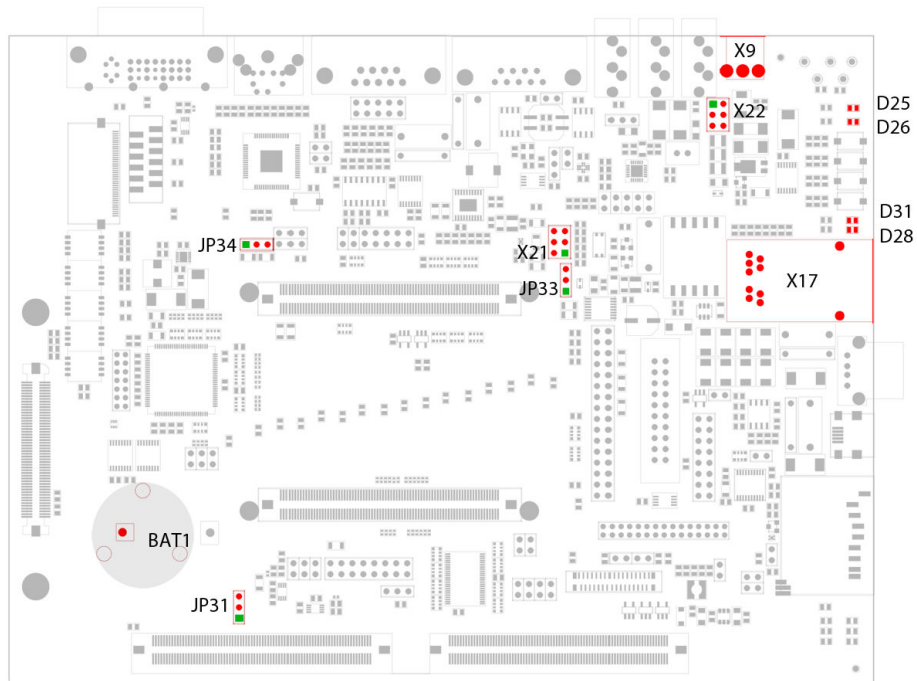
## 19 phyCORE-AM3517 SOM Connectivity



**Fig. 19-1.** phyCORE-AM3517 SOM Connectivity to the Carrier Board

Connector X15 on the Carrier Board provides the phyCORE-AM3517 System on Module connectivity. The connector is keyed for proper insertion of the SOM. [Figure 19-1](#) above shows the location of connector X15, along with the pin numbering scheme.

## 20 Power



**Fig. 20-1. Powering Scheme**

The phyCORE-AM3517 Carrier Board powering scheme provides two possible power sources:

1. Wall adapter power jack at X9
2. Power over Ethernet (PoE) Ethernet jack at X17

In order to generate the VCC\_5V0, primary input power is selected via jumper X22 and is supplied from either the wall adapter (via jack X9), or the Power over Ethernet circuit U14 (via Ethernet jack X17). All board power supplies ultimately generate power from VCC\_5V0 except the VBAT which is supplied from BAT1.

The VBAT terminals to the SOM are powered directly from the battery at BAT1. If this battery is installed and jumper JP31 is set to 2+3, then VBAT will always be present on an installed SOM and Carrier Board. Therefore, care should be taken before performing any electrical work on the boards to prevent shorting out this battery.

**CAUTION:**

Remove the battery, remove JP31, or remove the SOM from X15 before performing any electrical work.

The following sections in this chapter describe each power block in detail.

### 20.1 Wall Adapter Input (X9)

Permissible input voltage: +3.3V to +5 VDC regulated.

The primary input power to the phyCORE-AM3517 Carrier Board is located at connector X9. The required load current capacity of the power supply depends on the specific configuration of the phyCORE-AM3517 mounted on the Carrier Board, and the interfaces enabled while executing software. An adapter with a minimum supply of 2000mA is recommended.

A detailed list of applicable configuration jumpers is presented below.

- X22** Configures primary input power source. By default this jumper is set to 1+3/2+4, sourcing board power from the wall adapter input. Alternatively this jumper can be set to 3+5/4+6, sourcing board power from the Power over Ethernet circuit.
- D26** Shows the status of the input power supply (wall power or PoE). When illuminated the supply is active.

## 20.2 Power over Ethernet (PoE)

The Power over Ethernet (PoE) circuit provides a method of powering the board via the Ethernet interface. In this configuration the phyCORE-AM3517 Carrier Board acts as the Powered Device (PD) while the connecting Ethernet interface acts as the Power Source Equipment (PSE). For applications that require Ethernet connectivity, this is an extremely convenient method for simultaneously providing power. To make use of the PoE circuit you must have a PSE for connectivity. Typically a PoE enabled router or switch can be used. [Table 20-1](#) provides a list of possible Power Sourcing Equipment you can purchase to interface the phyCORE-AM3517 PoE circuit if you do not already have a PSE.

**Table 20-1. Possible Ethernet PSE Options**

Device	Description
FS108P	Netgear 8-port Ethernet switch with 4-port PoE support.
TPE-101I	TRENDnet single port PoE injector

The IEEE PoE standard restricts the maximum amount of power a PSE must provide and therefore a PD can consume. The phyCORE-AM3517 Carrier Board PoE circuit was designed to provide up to 8.5W of power to the board. Note that this is less than the wall adapter can supply and less than the SOM, Carrier Board, and additional circuits can potentially consume. The base configuration of the SOM and Carrier Board typically consume less than 2 watts. Be aware that this PoE limitation could cause board operation to fail if peak power capability is exceeded due to added peripherals. The phyCORE-AM3517 Carrier Board Ethernet connector X17 supports both PSE power sourcing methods of power over the data wires, or power over the spare wires.

A detailed list of applicable configuration jumpers and LED indicators is presented below.

- JP33** Controls the PoE signature resistor internal to the Linear Tech LTC4267 PoE IC. By default this jumper is set to the 2+3 position, enabling the 25k signature resistor. Alternatively this jumper can be set to the 1+2 position, disabling the 25k signature resistor. For normal operation this jumper should be set to the 2+3 position, but in some applications it may be necessary to disable the signature resistor.
- X22** Configures primary input power source. By default this jumper is set to 1+3/2+4, sourcing board power from the wall adapter input. Alternatively this jumper can be set to 3+5/4+6, sourcing board power from the Power over Ethernet circuit.

- D25** PoE 5V power indicator. When illuminated the PoE circuit is actively generating 5V.
- D28** Ethernet LINK status indicator. When illuminated the Ethernet interface has established a link to the network. This LED blinks when there is activity on the Ethernet interface.
- D31** Ethernet ACTIVITY status indicator. When illuminated the Ethernet interface is linked in 100Mbps mode.

### 20.3 Lithium-Ion Battery

The phyCORE-AM3517 Carrier Board utilizes a Lithium-Ion Battery (at Bat1) to power the RTC when main power is off. The PMIC on the SOM switches from main power to the Lithium-Ion Battery when the main power is turned off. The battery used in the BAT1 position is a Panasonic CR2032 or equivalent. The battery may be replaced with the system running on main power, but care should be taken to ensure the battery and/or battery holder terminals are not shorted during this process. The RTC requires one source of continuous power in order to keep time.

The applicable configuration jumper is presented below.

- JP31** Configures Carrier Board VBAT voltage supply. By default this jumper is set to 2+3, sourcing VBAT power from the Lithium-Ion battery. Alternatively this jumper can be set to 1+2, to ground the VBAT supply. Note, with VBAT at ground, the VRTC power rail is supplied only when VIN power is on, hence the RTC will not preserve time when VIN power is off.

### 20.4 3.3V Supply (U27)

The Linear Technology LTC3612EFE switching regulator (U27) powers the VCC\_3V3 power supply rail. This power supply powers most of the accessory circuits on the Carrier Board. It can optionally power the phyCORE-AM3517 SOM by supplying power to VIN. It can also optionally power the VCC\_IO power rail on the Carrier Board.

A detailed list of applicable configuration jumpers is presented below.

- X21** Configures Carrier Board VCC\_IO voltage level. By default this jumper is set to 3+5/4+6, sourcing VCC\_IO power from the 3.3V supply U27. Alternatively this jumper can be set to 1+3/2+4, sourcing VCC\_IO from the 1.8V regulator (U31).
- JP34** Configures VIN to the phyCORE-AM3517 SOM to be powered from VCC\_3V3 or VCC\_5V0 (3.3V-5.0V). By default this jumper is set to 2+3, sourcing VIN power to the SOM from VCC\_3V3. Alternatively this jumper can be set to 1+2, sourcing VIN to the SOM from VCC\_5V0.

### 20.5 1.8V Supply (U31)

The Linear Technology LTC3411 switching regulator (U31) powers the VCC\_1V8 power supply rail. This power supply powers a few accessory circuits on the Carrier Board. It can optionally power the VCC\_IO power rail on the Carrier Board.

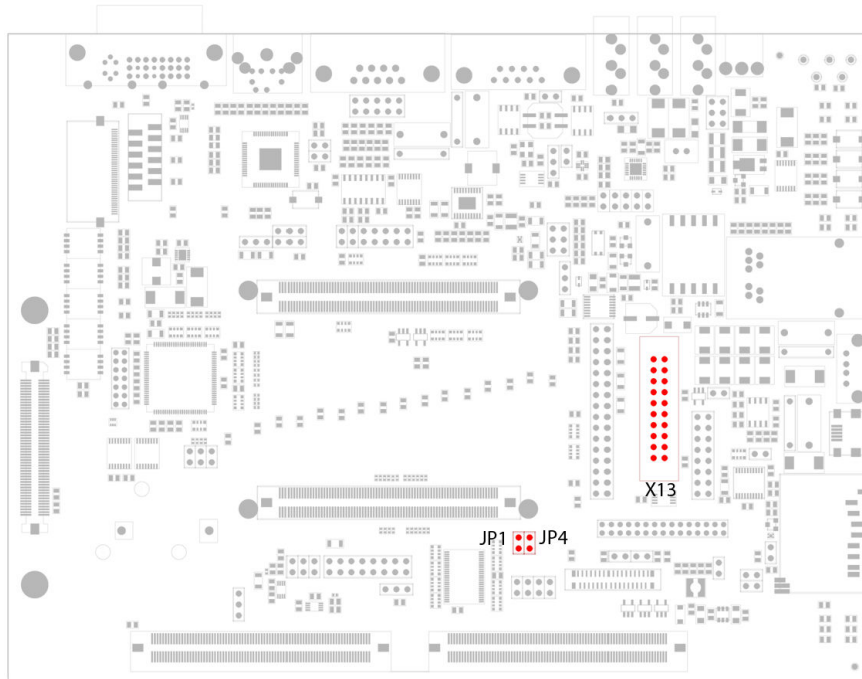
The applicable configuration jumper is presented below.

- X21** Configures Carrier Board VCC\_IO voltage level. By default this jumper is set to 3+5/4+6, sourcing VCC\_IO power from the 3.3V supply (U27). Alternatively this jumper can be set to 1+3/2+4, sourcing VCC\_IO from the 1.8V regulator (U31).

## 20.6 Current Measurement

To facilitate current measurement, jumpers R121 - R126 are provided as current access measurement points. Replace these jumpers with 1206 packaged precision shunt resistors and measure the resulting voltage drop across the shunt resistor to calculate current draw. A good value to start with for your shunt resistor is 25mΩ. The shunt resistor should be small enough to have no effect on the output voltage (it will be reduced by the voltage drop across the shunt), but large enough to have a discernible measurement from supply noise.

## 21 JTAG Connectivity



**Fig. 21-1. JTAG Probe Connectivity to the phyCORE-AM3517**

Connector X13 provides a convenient JTAG probe connection interface for ARM Cortex-A8 compatible JTAG probes to the AM3517. [Table 21-1](#) provides a detailed list of the signals at the JTAG connector. Cross reference this with a JTAG probe on the target application to ensure compatibility.

**Table 21-1. phyCORE-AM3517 JTAG Connector X13 Pin Descriptions**

Pin	Signal	Description
1	VTREF	Ref voltage input - connected to VCC=3.15V
2	VSUPPLY	Supply input - connected to VCC=3.15V
3	/TRST	Test controller reset input with internal 10k pull-up
4	GND	Ground
5	TDI	Test data input with internal 10k pull-up
6	GND	Ground
7	TMS	Test mode select input with internal 10k pull-up
8	GND	Ground
9	TCK	Test clock input with internal 10k pull-down
10	GND	Ground
11	RTCK	Return test clock output with internal 10k pull-down
12	GND	Ground
13	TDO	Test data output

**Table 21-1. phyCORE-AM3517 JTAG Connector X13 Pin Descriptions**

Pin	Signal	Description
14	GND	Ground
15	/SRST	System reset input with internal 10k pull-up
16	GND	Ground
17	N/C	No connect
18	GND	Ground
19	N/C	No connect
20	GND	Ground

As of the printing of this manual, [Table 21-2](#) lists JTAG probes which are known to be compatible to the phyCORE-AM3517 Carrier Board JTAG interface.

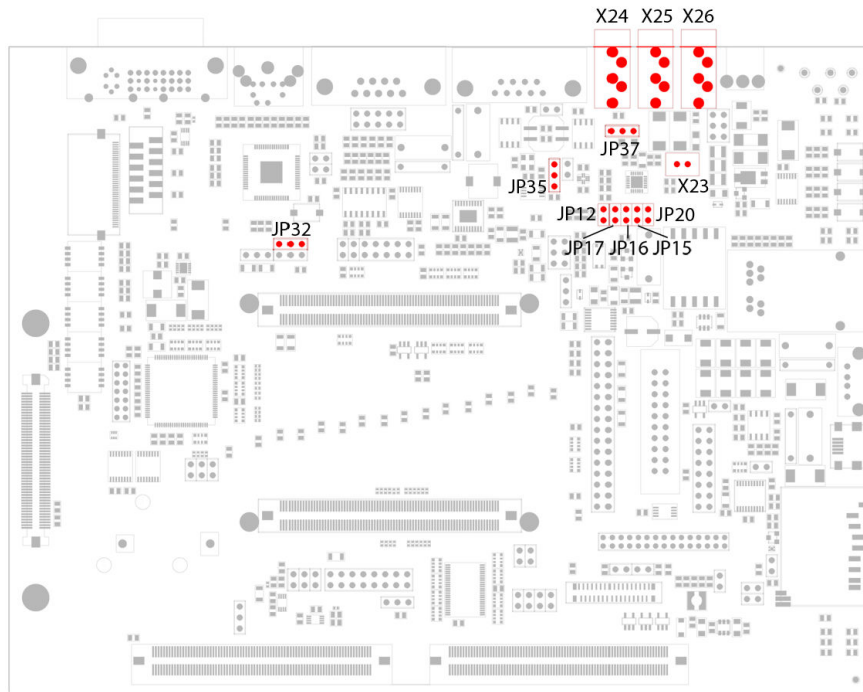
**Table 21-2. Compatible JTAG Probes for the phyCORE-AM3517 Carrier Board**

JTAG Probe Name
ARM Realview ICE

A detailed list of the connector and applicable LED indicators is presented below.

- X13** This connector provides a convenient interface for the AM3517's ARM Cortex-A8 processor to a compatible JTAG probe. [Table 21-1](#) provides a detailed list of the signals at the JTAG connector. Cross reference this with a JTAG probe on the target application to ensure compatibility.
- JP4** Reserved
- JP1** Reserved

## 22 Audio Interface



**Fig. 22-1. Audio Interface Connectors and Jumpers**

The audio interface provides a method of exploring the AM3517's I<sup>2</sup>S capabilities. The phyCORE-AM3517 Carrier Board is populated with a Wolfson Microelectronics' WM8974 mono audio codec.

This codec supports the following:

- Microphone input
- Line output
- Headphone output
- Loudspeaker

The WM8974 is interfaced to the phyCORE-AM3517 SOM via the I<sup>2</sup>S on McBSP2 port for audio data and the I<sup>2</sup>C port 2 for codec configuration. The codec is clocked from the processor SYS\_CLKOUT1 (optional) or from a crystal oscillator on the Carrier Board (default). JP35 and JP32 configuration allows flexible control over board audio clock source. See [Table 18-1](#) for jumper configuration settings.

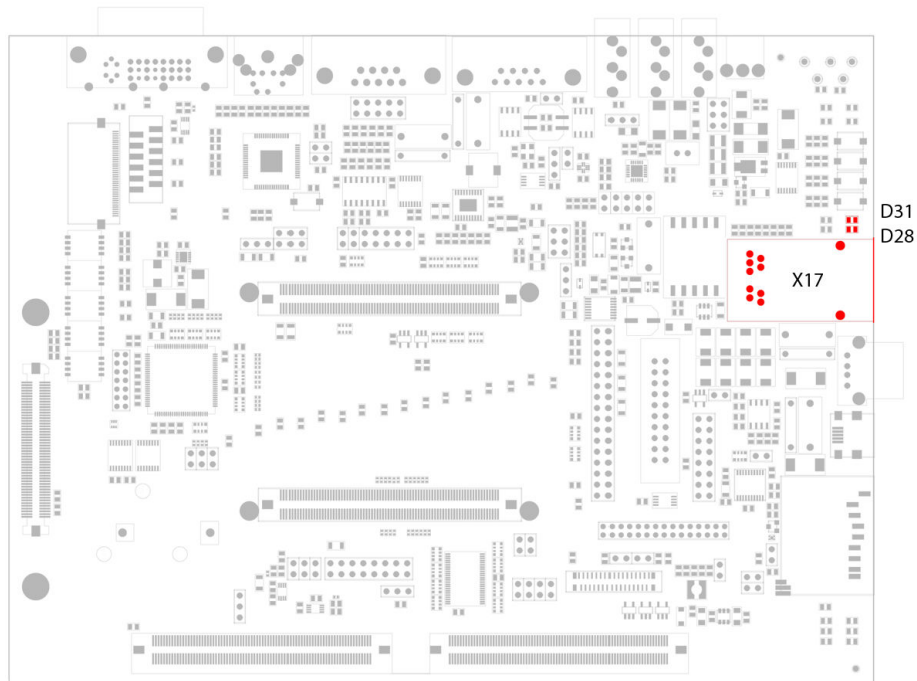
A detailed list of applicable connectors and configuration jumpers is presented below.

- X23** Loud speaker out for connecting to a speaker (8 ohms).
- X24** MIC jack input for connecting to a compatible electret type microphone. The MIC is biased via a 10k pull-up to WM8974's MIC bias drive. Ensure that this does not exceed the biasing requirements of the MIC.
- X25** Stereo Headphone Output jack for connecting to a set of headphones. This output is capable of driving a 8 Ohm load.



- 
- X26** Line Output jack for connection to an applicable audio input source capable of receiving a ~0.945V RMS (typical) input signal (such as the LINE INPUT on a PC).
- X23** MIC bias configuration jumper is by default set to the 1+2 position, biasing a mono input microphone. This jumper may be useful for independently biasing and using either channel of a stereo MIC. Set this jumper to the 2+3 position to use and bias the right channel and 1+2 for the left channel.
- JP12** Connects the MCBSP2\_DR processor signal to the audio codec. By default this jumper is set to the closed position. Open this jumper to free this signal for external use.
- JP15** Connects the MCBSP2\_CLKX processor signal to the audio codec. By default this jumper is set to the closed position. Open this jumper to free this signal for external use.
- JP16** Connects the MCBSP2\_FSX processor signal to the audio codec. By default this jumper is set to the closed position. Open this jumper to free this signal for external use.
- JP17** Connects the MCBSP2\_DX processor signal to the audio codec. By default this jumper is set to the closed position. Open this jumper to free this signal for external use.
- JP20** GPIO out of audio chip. This jumper is for test purposes only. Do not install this jumper.
- JP35** Selects audio codec clock source. By default this jumper is set to the 1+2 position to use the external crystal oscillator OZ1. Set jumper to 2+3 to use SYS\_CLKOUT1 clock signal from AM3517 processor.
- JP32** This jumper causes the SYS\_CLKOUT1 from the SOM to be connected to nets xSYS\_CLKOUT1A or xSYS\_CLKOUT1B. Set this jumper in the 1+2 position to connect SYS\_CLKOUT1 to SYSCLKOUT1A net which connects to the audio section. Set this jumper in the 2+3 position to connect SYS\_CLKOUT1 to SYSCLKOUT1B net which connects to the expansion connector.
- JP37** This jumper is used to supply bias current to the microphone. Position 1+2 generates a bias current on the tip. Position 2+3 generates bias current on the ring. The correct setting for this jumper will depend on the wiring for the MIC. Refer to the microphone's documentation for correct bias wiring.

## 23 Ethernet Connectivity



**Fig. 23-1. Ethernet Interface Connector and LEDs**

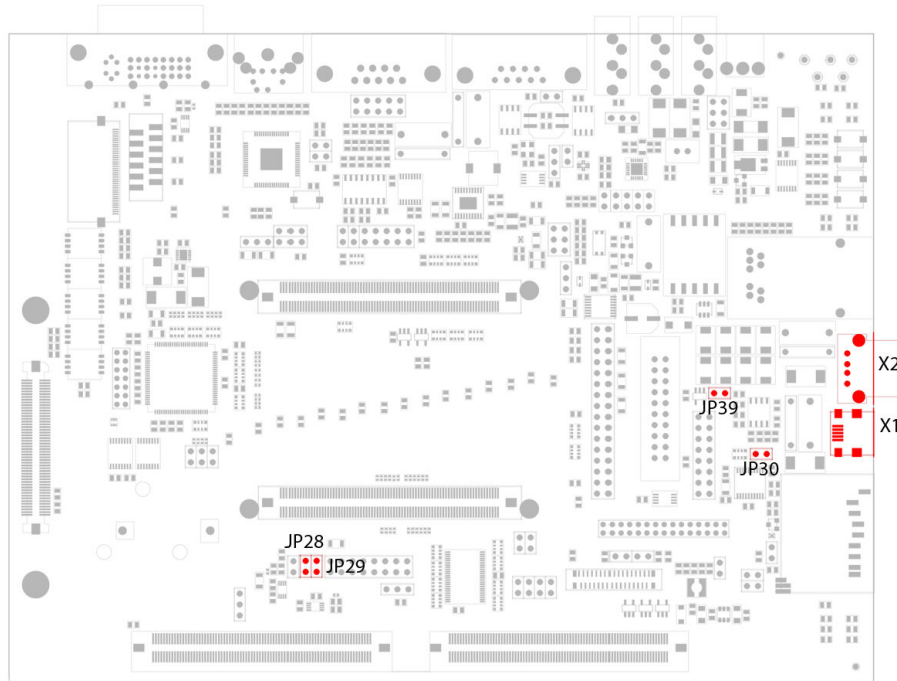
The Ethernet interface provides a method of connecting to the phyCORE-AM3517 Ethernet functionality. One RJ-45 connector is provided at X17. This connector provides both a connection to the Ethernet data signals and the Power over Ethernet power signals. A LINK/ACTIVITY and SPEED LED are provided on the Carrier Board at D31 and D26.

A detailed list of the connector and applicable LED indicators is presented below.

- X17** This 10/100 Base-T Ethernet connect provides a standard Ethernet cable connection point for the AM3517 to a network. This interface supports PoE injection as well as Ethernet connectivity. In addition, this Ethernet interface supports straight and crossover cable wiring through the AUTOMDIX function of the 10/100 PHY.
- D28** Ethernet LINK/ACTIVITY status indicator. When illuminated the Ethernet interface has established a link to the network. This LED blinks when there is activity on the Ethernet interface.
- D31** Ethernet SPEED status indicator. When illuminated the Ethernet interface is linked in 100Mbps mode.

For information on using the Power over Ethernet circuit refer to [Chapter 20.2](#).

## 24 USB Connectivity



**Fig. 24-1. USB Interface Connectors and Jumpers**

The USB connectors provide connectivity to the phyCORE-AM3517's two USB interfaces. Peripheral connector X2 provides the dedicated host interface. This is connected to the USB1 interface on the AM3517 through a USB PHY. Connector X1 provides a Mini-AB OTG interface, which is connected to the USB0 (internal PHY) interface on the AM3517.

The host interface is provided with an additional 5V supply current for robust peripheral power.

The OTG interface has configuration jumpers, along with additional 5V supply current for non-OTG peripherals. A USB OTG compliant device is only required to source up to 8mA of current when operating as a host. Because very few devices are OTG compliant and most USB peripherals require more than 8mA to operate, a 5V power circuit and configuration jumper have been provided to facilitate these devices.

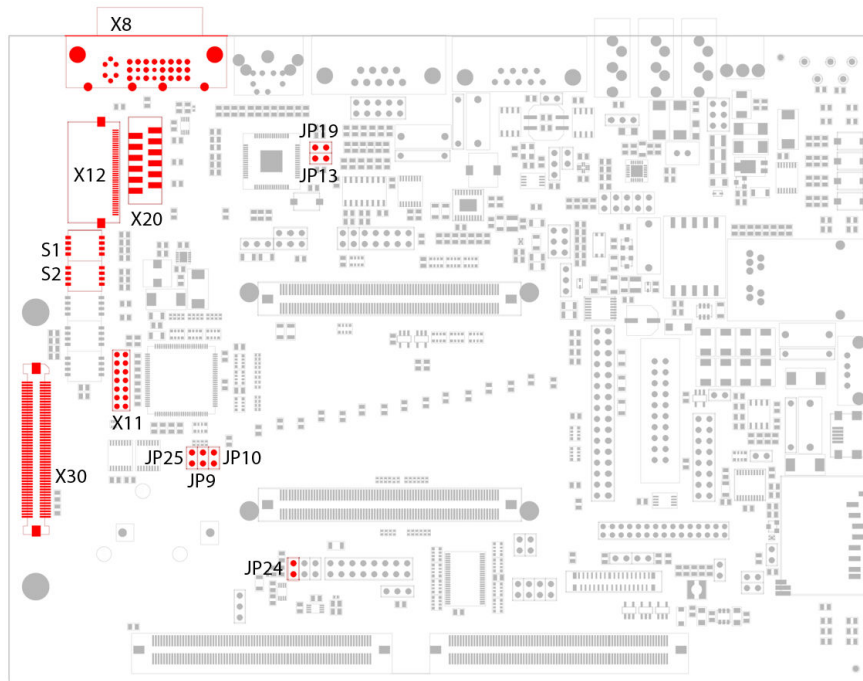
Both USB interface's VBUS power is current limited by U1 (TPS2052BD)

A detailed list of applicable configuration jumpers and connectors is presented below.

- X2** USB Standard-A host connection interface. Connect a USB Standard-A mating cable to this connector when operating this USB interface in host mode.
- X1** USB Mini-AB OTG connection interface. Connect a USB OTG cable to this connector when operating the USB interface in OTG mode. Connect a USB mini-B connector to this interface to use in peripheral mode.

- JP39** This jumper grounds the ID pin on X1's OTG port. Use this jumper to make this port a host port.
- JP30** This jumper adds additional capacitance to the OTG port's VBUS. With this jumper OPEN a capacitor of 4.7 $\mu$ F is connected to VBUS. When this jumper is CLOSED a 150 $\mu$ F capacitor is placed in parallel to the 4.7 $\mu$ F capacitor on VBUS.
- JP28** This jumper connects the over-current indication for USB1 interface (X2) to the AM3517. Removing this jumper makes the GPMC\_WAIT2 signal available for external use.
- JP29** This jumper connects the over-current indication for USB0 interface (X1) to the AM3517. Removing this jumper makes the GPMC\_WAIT3 signal available for external use.

## 25 LCD and DVI Connectivity



**Fig. 25-1. LCD/DVI Interface Connectors, Jumpers, and Switches**

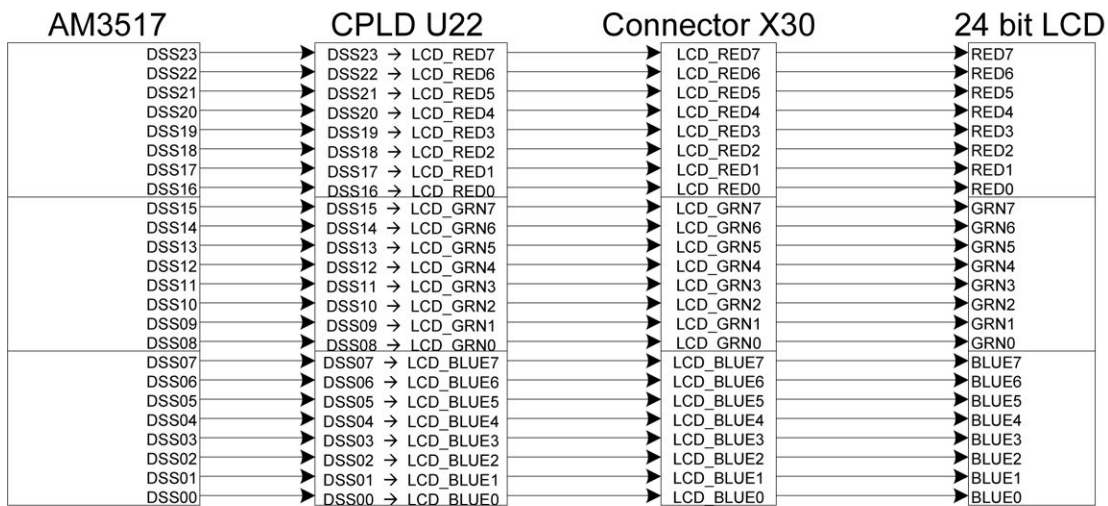
The phyCORE-AM3517 Carrier Board provides flexible LCD and DVI connection interfaces to support various PHYTEC provided LCD boards. The universal LCD connector X30 provides power and buffered signals to connecting LCDs.

The universal LCD interface consists of the following components:

1. CPLDs for buffered signals and color signal control
2. Mode set jumpers for various LCD color bit encoding modes
3. Buffered I<sup>2</sup>C interface
4. PWM controlled backlight and LCD enable

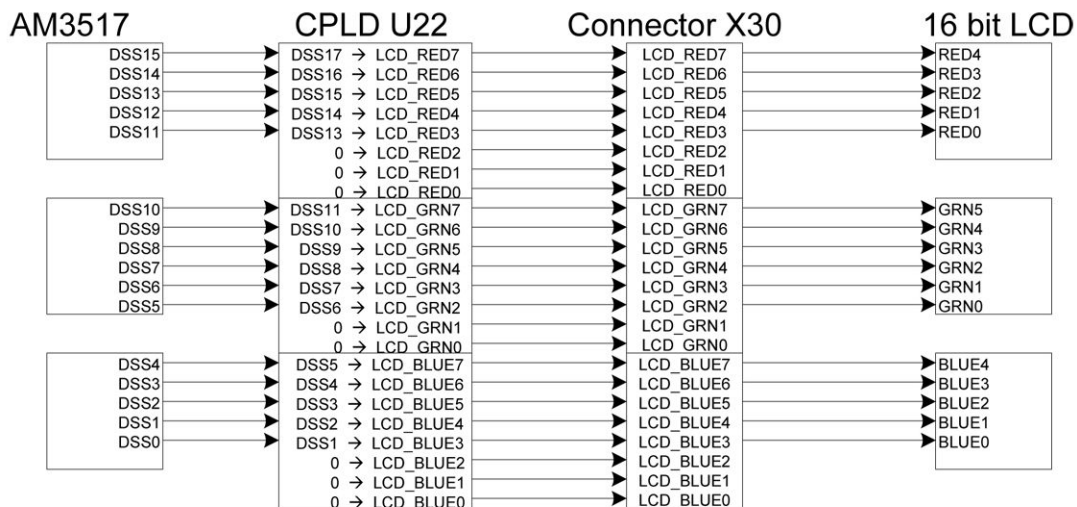
The CPLDs come pre-programmed; supporting the 24bpp (8:8:8), 18bpp (6:6:6), 16bpp (5:6:5), and 12bpp (4:4:4) modes allowed on the AM3517 LCD controller. Color signal control allows dynamic reconfiguration of the color signals to support various LCD bit widths.

As an example, consider only the blue color signals from a 24-bit LCD. In the case of a 24-bit LCD [Figure 25-2](#) shows the connection interface from the AM3517 DSS port all the way to the LCD. As can be seen DSS23...16 from the processor map directly to LCD\_RED7...0 via the CPLD U22.



**Fig. 25-2. LCD Signal Mapping in 24-bit Mode with a 24-bit LCD**

In the case of an 16-bit LCD, [Figure 25-3](#) shows the lower 3-bits of the RED signals to the connector X30 are held to 0 (low) by the CPLD when operating the AM3517 in 16-bit 5:6:5 mode. The result is that the upper 5 bits of the LCD blue interface are driven with the blue color data provided by the AM3517. The lower blue LCD bits 2...0 are driven to 0 by the CPLD (since this data bit is not provided by the 16-bit operating mode of the AM3517). The upper 8 bits of the AM3517 DSS interface (DSS23...16) are freed for use as their alternative functions when operating in this mode.



**Fig. 25-3. LCD Signal Mapping in 16-bit Mode with an 16-Bit LCD**

[Figure 25-3](#) shows a detailed mapping of the AM3517 LCD port signals through the CPLD. In general the CPLD is acting as a buffer, mapping LCD23...16 directly to LCD\_BLUE7...0, LCD15...8 to LCD\_GREEN7...0, and LCD7...0 to LCD\_RED7...0. The only time this is not true is for the lower LCD color bits for 16-bit and 12-bit mode. In the 16-bit modes (5:6:5 and 5:5:5) and 12-bit mode (4:4:4) the unused LCD bits on the AM3517 LCD port are not buffered through the CPLD. Instead the CPLD holds these signals low for these operating modes.

Table 25-1, Table 25-2, Table 25-3, and Table 25-4 show the signal mapping for the four LCD bit modes (C=CLOSED; O=OPEN):

**Table 25-1. 24-bit 8:8:8 mode (S1-1,S1-2, S1-3, S1-4 = O,O,O,O)**

AM3517 Signal		LCD Connector X30 Signal
DSS23...16	→	LCD_RED7...0
DSS15...8	→	LCD_GRN7...0
DSS7...0	→	LCD_BLUE7...0

**Table 25-2. 12-bit 4:4:4 mode (S1-1,S1-2, S1-3, S1-4 = C, C, C, O)**

AM3517 Signal		LCD Connector X30 Signal
DSS11...8	→	LCD_RED7...4
DSS7...4	→	LCD_GRN7...4
DSS3...0	→	LCD_BLUE7...4

**Table 25-3. 16-bit 5:6:5 mode (S1-1,S1-2, S1-3, S1-4 = C, C, O, C)**

AM3517 Signal		LCD Connector X30 Signal
DSS15...11	→	LCD_RED7...3
DSS10...5	→	LCD_GRN7...3
DSS4...0	→	LCD_BLUE7...3

**Table 25-4. 18-bit 6:6:6 mode (S1-1,S1-2, S1-3, S1-4 = C, C, O, O)**

AM3517 Signal		LCD Connector X30 Signal
DSS17...12	→	LCD_RED7...2
DSS11...6	→	LCD_GRN7...2
DSS5...0	→	LCD_BLUE7...2

Table 25-5 shows a summary of the required switch settings for each of the AM3517 LCD operating modes.

**Table 25-5. LCD Mode Jumper Summary (S1-1,S1-2, S1-3, S1-4)**

LCD Mode	Switch Settings (S1-1, S1-2, S1-3, S1-4)
24-bit 8:8:8	OPEN, OPEN, OPEN, OPEN
18-bit 6:6:6	CLOSED, CLOSED, CLOSED, OPEN
16-bit 5:6:5	CLOSED, CLOSED, OPEN, CLOSED
12-bit 4:4:4	CLOSED, CLOSED, OPEN, OPEN

## 25.1 DVI Connector

A DVI connector is provided at X8, see Figure 25-1. The DVI encoder (U28) formats the DSS video signals in 24 bit mode appropriately for any DVI (digital) compatible monitor. The DVI output operates in parallel with the LCD outputs so the DVI, LVDS LCD and TTL LCD ports can simultaneously drive video to their respective connectors.

A detailed list of the connector and applicable configuration jumpers is presented below

- JP19** This jumper is used to allow the AM3517 to put the DVI encoder into a power down mode. CLOSE this jumper to allow AM3517 control of the power down. OPEN this jumper to allow GPIO\_155 to be used as a GPIO.
- JP13** This jumper is used to set the DVI encoder IO voltage levels to 1.8V or 3.3V. CLOSE this jumper to operate SOM IOs at 1.8V; OPEN to use 3.3V IOs.
- X8** DVI (digital) interface connector. This can be connected to a digital DVI compatible monitor; resolution must be consistent with SOM BSP configuration.

## 25.2 LVDS Connectors

Two connectors are provided to support LVDS LCDs. The LVDS signaling connector is provided at X12 and the power connector is at X20. The LVDS output operates in parallel with the DVI and TTL LCD outputs so the DVI and TTL LCD ports can simultaneously drive video to their respective connectors.

A detailed list of applicable configuration jumpers, switches, and connectors is presented below.

- JP25** LCD backlight control jumper. By default this jumper is CLOSED, selecting processor signal ETK\_D14 to control LCD backlight. OPEN this jumper to permanently turn on the LCD backlight. When this jumper is removed, the processor signal ETK\_D14 becomes free for external use.
- S2** Reserved
- JP24** LCD PWM control jumper. By default this jumper is CLOSED, selecting processor signal GPMC\_NCS2 to control LCD backlight PWM (brightness). OPEN this jumper to permanently disable LCD backlight control. When this jumper is removed, the processor signal GPMC\_NCS2 becomes free for external use.



- X12** LVDS LCD signaling connector. This can be used to connect an LUD supported LCD such as the PHYTEC LCD-014
- X20** LVDS LCD power connector. This can be used to power an LCD such as the PHYTEC LCD-014
- JP9** LCD SPI SOMI jumper. By default this jumper is CLOSED, selecting processor signal MCSP11\_SOMI to interface to the LCD SPI EEPROM. OPEN this jumper to permanently disable LCD EEPROM access. When this jumper is removed, the processor signal MCSP11\_SOMI becomes free for external use.
- JP10** LCD SPI IRQ jumper. By default this jumper is CLOSED, selecting processor signal MCSP11\_CS3 to interface to the LCD SPI interrupt. OPEN this jumper to permanently disable LCD SPI interrupt. When this jumper is removed, the processor signal MCSP11\_CS3 becomes free for external use.

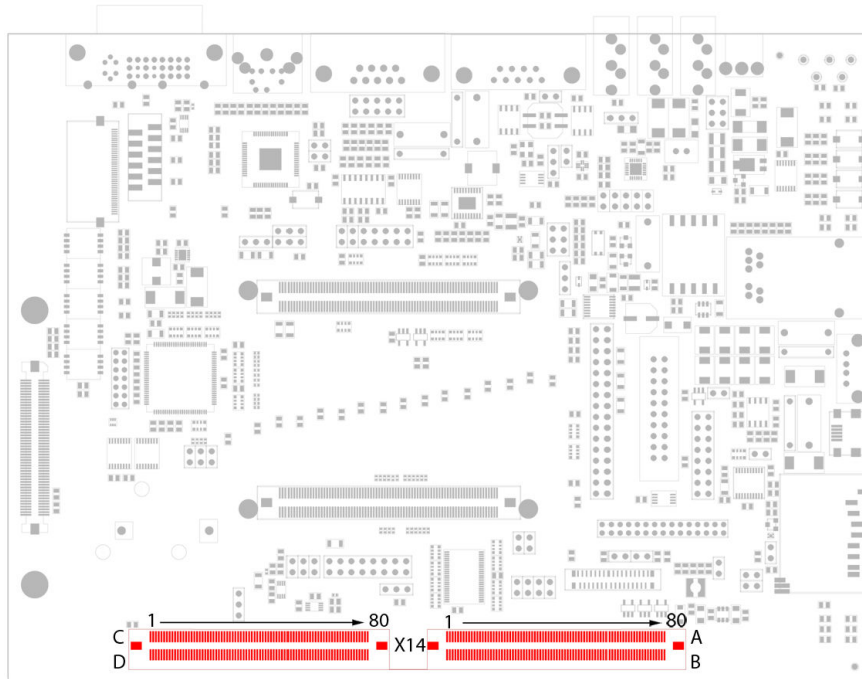
### 25.3 TTL LCD Connector

Connector X30 and a level translator (U22) are provided to interface to a PHYTEC standard TTL LCD such as the LCD-011. This interface uses standard 3.3V TTL level signaling that can be used to interface to other standard TTL level LCDs with 12, 16, 18, or 24 bit interfaces. A CPLD is provided for convenience in switching between various bit modes and LCD bit depths during software development. In the target application, the CPLD is not required. See [Table 25-5](#) for detailed list of switch settings for these various bit mode settings.

A detailed list of the applicable switch, and connectors is presented below.

- S1** Configures the LCD operating mode. By default these switches are set to OPEN, OPEN, OPEN, OPEN resulting in the 24-bit 8:8:8 operating mode. See [Table 25-5](#) for a detailed list of switch settings and corresponding operating modes.
- X30** TTL LCD interface connector
- X11** CPLD JTAG connector, reserved

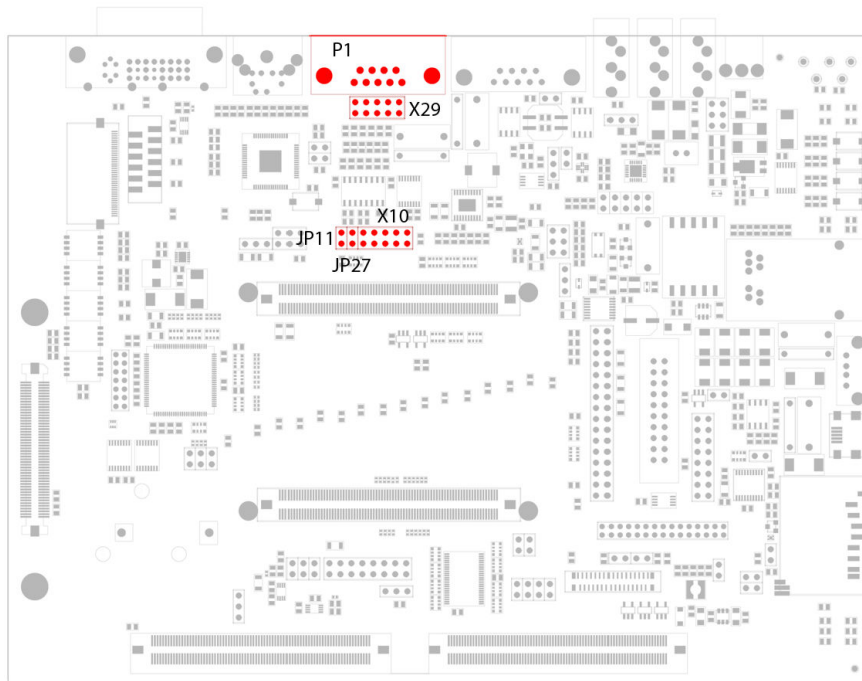
## 26 GPIO Expansion Connector



**Fig. 26-1. GPIO Expansion Connector**

Figure 26-1 shows the location of the GPIO expansion port connector X14. This connector provides a 1:1 mapping of most of the phyCORE-AM3517 mating connector X15 signals. Additional signals generated on the Carrier Board are also routed to the GPIO expansion port connector X14. As an accessory, a GPIO Expansion Board (part # PCM-988) is made available through PHYTEC to mate with the X14 connector on the phyCORE-AM3517 Carrier Board. This Expansion Board provides a patch field for easy access to all signals, plus additional board space for testing and prototyping. A summary of the signal mappings between X14, X15, and the patch field on the GPIO Expansion Board is provided in [Part III](#).

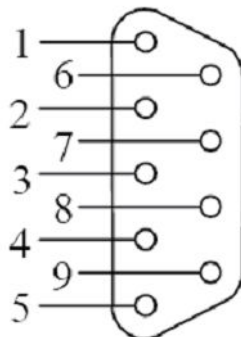
## 27 RS-232 Connectivity



**Fig. 27-1. RS-232 Interface Connectors and Jumpers**

Female DB9 connector P1, and a 10 pin 0.1"/2.54mm spaced header (X29) provide connectivity to the phyCORE-AM3517 UART3 and UART2 interfaces at RS-232 levels. Connector P1 is dedicated to UART3, while X29 is dedicated to UART2. In addition to these connectors, a 0.1"/2.54mm header at X10 is provided for easy access the UART2 and UART3 signals at TTL levels.

Figure 27-2 shows the pin numbering for the DB9 connectors, while Table 27-1 and Table 27-2 give a detailed description of the signals at P1 and X29.

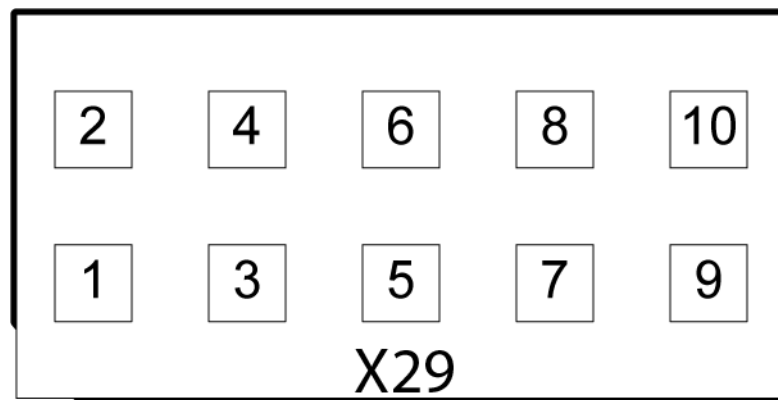


**Fig. 27-2. DB9 RS-232 Connectors P1 (UART3) Pin Numbering**

**Table 27-1. Connector P1 (UART3) Pin Descriptions**

Pin	Signal	I/O	Description
1	N/C	-	Not connected
2	U3_TX_RS232	O	UART3 transmit
3	U3_RX_RS232	I	UART3 receive
4	N/C	-	Not connected
5	GND	-	Ground
6	N/C	-	Not connected
7	N/C	-	Not connected
8	N/C	-	Not connected
9	N/C	-	Not connected

Figure 27-3 shows a detail of the pin numbering at the UART2 header (X29) while Table 27-2 gives a description of signals. Pin number 1 can be found by looking for the beveled silk-screen around the header.

**Fig. 27-3. Connector X29 (UART2) Pin Numbering****Table 27-2. Connector X29 (UART2) Pin Descriptions**

Pin	Signal	I/O	Description
1	N/C	-	Not connected
2	UART2_RX_RS232	I	UART 2 receive
3	UART2_TX_RS232	O	UART 2 transmit
4	N/C	-	Not connected
5	GND	-	Ground
6	N/C	-	Not connected
7	UART2_RTS_RS232	O	Ready to send

**Table 27-2. Connector X29 (UART2) Pin Descriptions**

Pin	Signal	I/O	Description
8	UART2_CTS_RS232	I	Clear to send
9	N/C	-	Not connected
10	N/C	-	Not connected

Figure 27-4 shows a detail of the pin numbering at connector X10. Pin number 1 can be identified by the beveled silk-screen around the header.

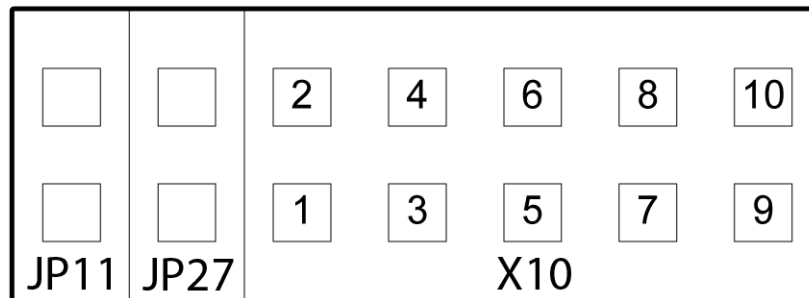
**Fig. 27-4. UART3/UART2 Header Connector X10 Pin Numbering**

Table 27-3 gives detailed pin numbering descriptions at the TTL/RS-232 UART header (X10).

**Table 27-3. TTL UART Pin Header (X10) Descriptions**

Pin	Signal	I/O	Description
1	UART3_RTS	O	UART3 ready to send, TTL levels
2	UART2_TXD	O	UART2 transmit data, TTL levels
3	UART3_CTS	I	UART3 clear to send, TTL levels
4	UART2_RTS	O	UART2 ready to send, TTL levels
5	UART3_TX_R	O	UART3 transmit, RS-232 levels S232
6	UART2_RXD	I	UART2 receive data, TTL levels
7	UART3_RX_	I	UART3 receive, RS-232 levels RS232
8	UART2_CTS	I	UART2 clear to send, TTL levels
9	VCC_IO	-	IO power (1.8V or 3.3V)
10	GND	-	Ground

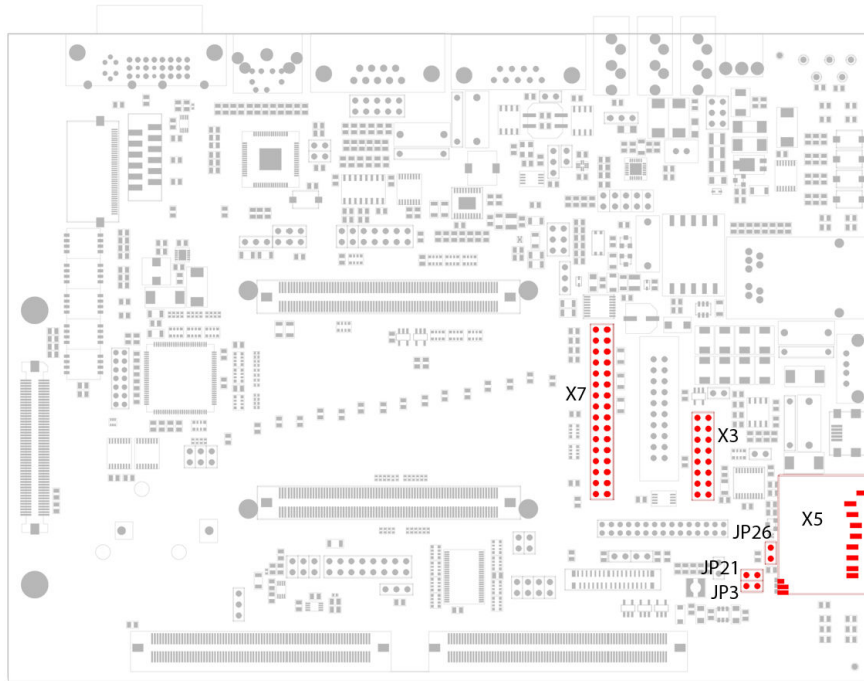
In addition to the three access connectors, two configuration jumpers are provided to free up signals for alternative use. A detailed list of the applicable connectors and configuration jumpers is presented below.

**P1**            UART3 connection point. This connector supports RS-232 level signals.

**X29**            UART2 connection point. This connector supports RS-232 level signals.

- X10** This header provides access to the UART2 and UART3 TTL level signals for debug.
- JP11** Connects UART2\_RXD signal to the RS-232 transceiver, through a level translator. By default this jumper is in the CLOSED position, enabling RS-232 communication. OPEN this jumper to free up UART2\_RXD for external use.
- JP27** Connects UART2\_CTS signal to the RS-232 transceiver, through a level translator. By default this jumper is in the CLOSED position, enabling RS-232 communication. OPEN this jumper to free up UART2\_CTS for external use.

## 28 SD/SDIO/MMC Connectivity



**Fig. 28-1. SDIO Interface Connectors and Jumpers**

Connector X5 provides connectivity to the phyCORE-AM3517's SD/SSDIO/MMC1 card interface. In addition, header connector X3 has been provided for easy access to the SD/SDIO/MMC1 card signals for probing purposes. An instant-on 3.3V power supply capable of supplying 1.2A of current has been provided for dynamic power control to the connected SD/SDIO/MMC card. The power circuit is controlled via the card detect function of the SD card connector and the processor signal MMC1\_DAT5. At initial card insertion, the power supply is turned on by a GPIO. After discovery, the processor can disable this power if desired. Set MMC1\_DAT5 high to turn the SD/SDIO/MMC1 power ON and low to turn the SD/SDIO/MMC1 power off.

The phyCORE-AM3517 supports an additional SD/SDIO/MMC interface which is used in the wireless connector and is documented in [Chapter 30](#).

Several configuration jumpers are provided for control of the SD/SDIO/MMC1 interface. A detailed list of applicable configuration jumpers and connectors is presented below.

- JP26** Connects the buffered processor signal MMC1\_DAT5 to the SD/SDIO/MMC power control circuit. By default this jumper is set to the CLOSED position, enabling processor control over the SD/SDIO/MMC power supply. Set this jumper to the OPEN position to free up MMC1\_DAT5 for external use.
- JP21** Connects processor signal MMC1\_DAT7 to the SD/SDIO/MMC card detect output. By default this jumper is set to the CLOSED position, enabling the processor to detect SD/SDIO/MMC card presence. Set this jumper to the OPEN position to free up the MMC1\_DAT7 signal for external use.

- JP3** Connects the processor signal MMC1\_DAT6 to the SD/SDIO/MMC card write protect output. By default this jumper is set to the CLOSED position, enabling the processor to detect the SD/SDIO/MMC card write protect state. Set this jumper to the OPEN position when using the SD/SDIO/MMC card slot with SDIO devices. Remove this jumper to free up MMC1\_DAT6 for external use
- X7** Connection point for a WIFI/Bluetooth module, such as the PHYTEC PCM-958
- X5** MMC1/SD Card/ SDIO card connector. This connector supports the MMC, SD Card or SDIO standard interface and is form factor compatible with these standards.
- X3** Provides a convenient access point to the signals on X5 to aid in debug.

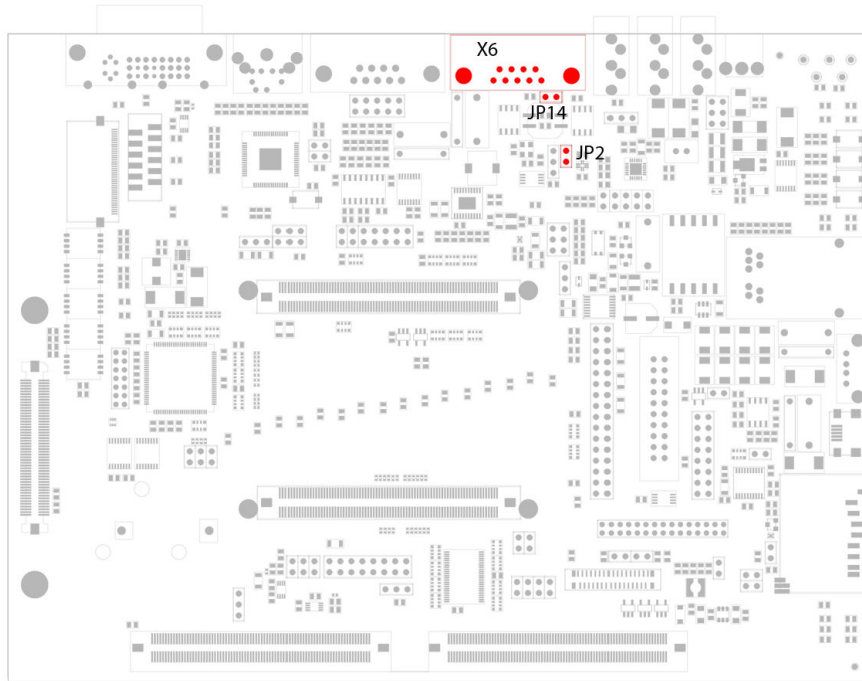
Table 28-1 shows the signal locations and descriptions on the connector.

**Table 28-1. SDIO Easy Access Header Connector Signal Descriptions**

Pin	Signal	I/O	Description
1	xMMC1_CLK	O	SD/SDIO/MMC clock
2	xMMC1_CMD	O	SD/SDIO/MMC command
3	xMMC1_DAT0	IO	SD/SDIO/MMC data 0
4	xMMC1_DAT1	IO	SD/SDIO/MMC data 1
5	xMMC1_DAT2	IO	SD/SDIO/MMC data 2
6	xMMC1_DAT3	IO	SD/SDIO/MMC data 3
7	xMMC1_DAT4	IO	SD/SDIO/MMC data 4
8	xMMC1_DAT5	IO	SD/SDIO/MMC data 5
9	xMMC1_DAT6	IO	SD/SDIO/MMC data 6
10	xMMC1_DAT7	IO	SD/SDIO/MMC data 7
11	N/C	-	Not connected
12	N/C	-	Not connected
13	GND	-	Ground
14	VCC_MMC1	-	SD/SDIO/MMC power
15	GND	-	Ground
16	VCC_MMC1	-	SD/SDIO/MMC power



## 29 CAN (Controller Area Network) Interface



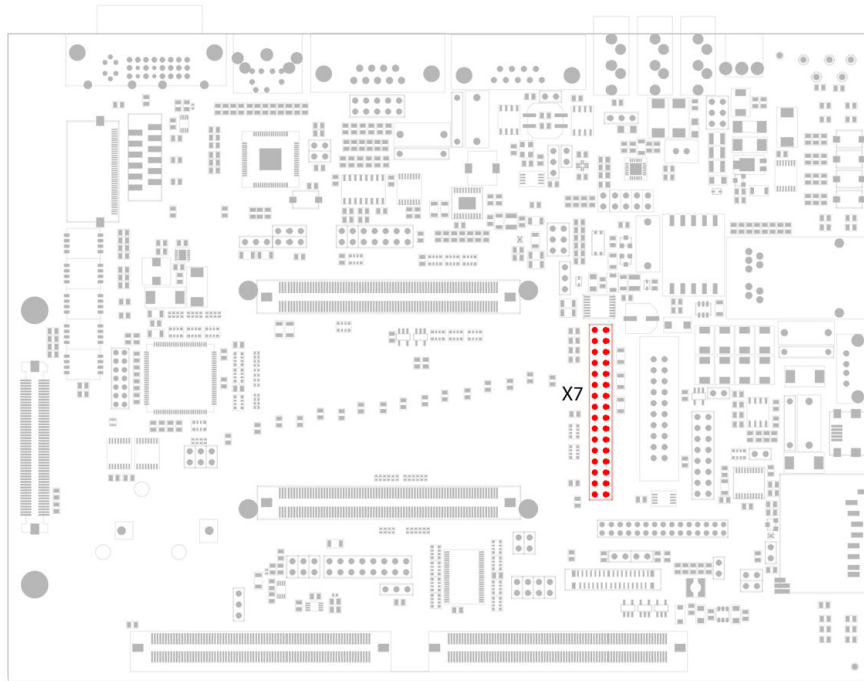
**Fig. 29-1. CAN Interface Connectors and Jumpers**

The phyCORE-AM3517 Carrier Board provides all necessary circuitry to connect the AM3517 HECC (High End CAN Controller) on the phyCORE SOM to a CAN bus via the DB9 style connector at X6. A 3.3V high-speed CAN transceiver (SN65HVD234) populates U11. This transceiver converts the single-ended CAN signals of the controller to the differential signals of the physical layer; supporting specifications within the ISO 11898 standard. It is capable of supporting signal rates of up to 1 Mbps. Additional ESD protection and EMI filtering is also integrated on the Carrier Board. CAN bus line termination can be enabled using a removable jumper (JP14). This interface is CAN version 2.0B compliant.

Below is a detailed list of the jumpers and connector associated with the CAN interface.

- X6** Standard CAN 2.0B connection point in a DB9 connector.
  
- JP14** In the CLOSED position, this jumper provides termination impedance at the Carrier Board. This is used when the phyCORE-AM3517 Carrier Board is the end point of a CAN network. Jumper position should be OPEN if the phyCORE-AM3517 Carrier Board is an intermediate node on the CAN network.
  
- JP2** The CLOSED position connects the CAN transceiver (U11) to the HECC1\_RXD signal on the SOM. Leave this CLOSED if the CAN interface is used; OPEN this jumper to free up the HECC\_RXD for external use.

### 30 Wireless Connector



**Fig. 30-1. Wireless Interface Connector**

The wireless connector (X7) is a 0.1"/2.54mm 2x16 header. It houses a collection of SDIO, UART and I<sup>2</sup>S interfaces required to connect to a WIFI/Bluetooth module, such as the PHYTEC PCM-958.

Table 30-1 is a detailed list of the signals on this connector.

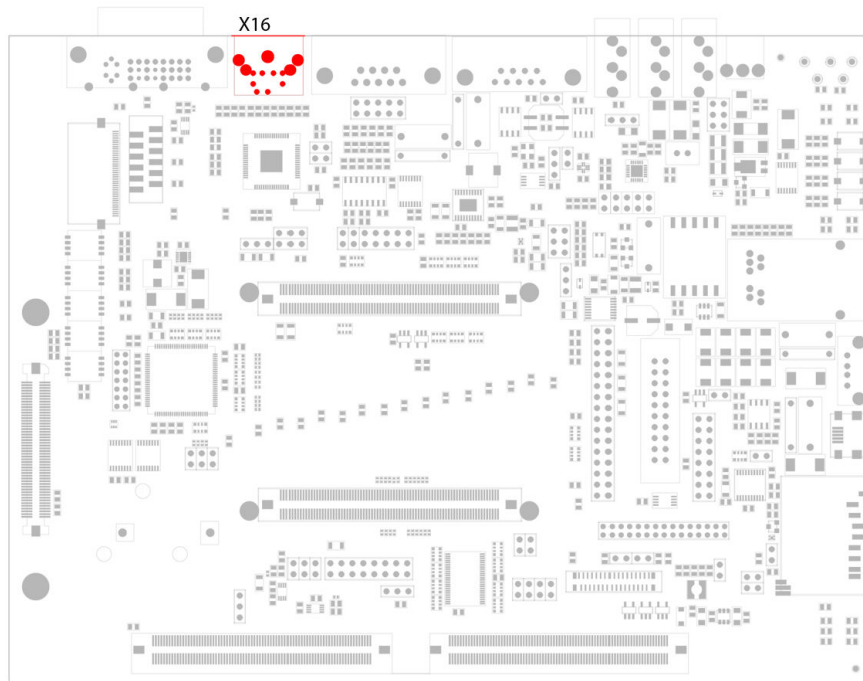
**Table 30-1. Wireless Connector (X7) Signal Descriptions**

Pin	Signal	I/O	Description
1	MCBSP1_FSX	I	I <sup>2</sup> S framing signal
2	GND	-	Ground
3	MCBSP1_DX	O	I <sup>2</sup> S data transmit
4	VCC_1V8	-	Power (1.8V)
5	MCBSP1_CLKX	O	I <sup>2</sup> S clock
6	VCC_1V8	-	Power (1.8V)
7	GND	-	Ground
8	GND	-	Ground
9	UART1_TX	O	UART 1 transmit data
10	VCC_IO	-	IO Power (1.8V or 3.3V)
11	UART1_RTS	O	UART 1 ready to send
12	VCC_IO	-	IO power (1.8V or 3.3V)
13	MMC2_DAT5	IO	SDIO data 5

**Table 30-1. Wireless Connector (X7) Signal Descriptions**

Pin	Signal	I/O	Description
14	VCC_3V3	-	Power (3.3V)
15	GND	-	Ground
16	VCC_3V3	-	Power (3.3V)
17	MMC2_DAT4	IO	SDIO data 4
18	GND	-	Ground
19	MMC2_DAT6	IO	SDIO data 6
20	MCBSP1_DR	I	I <sup>2</sup> S data in
21	MMC2_DAT3	IO	SDIO data 3
22	UART1_RX	I	UART 1 receive data
23	GND	-	Ground
24	UART1_CTS	I	UART 1 clear to send
25	MMC2_DAT2	IO	SDIO data 2
26	GND	-	Ground
27	MMC2_DAT1	IO	SDIO data 1
28	MMC2_DAT7	IO	SDIO data 7
29	MMC2_DAT0	IO	SDIO data 0
30	MMC2_CMD	O	SDIO command
31	GND	-	Ground
32	MMC2_CLK	O	SDIO clock

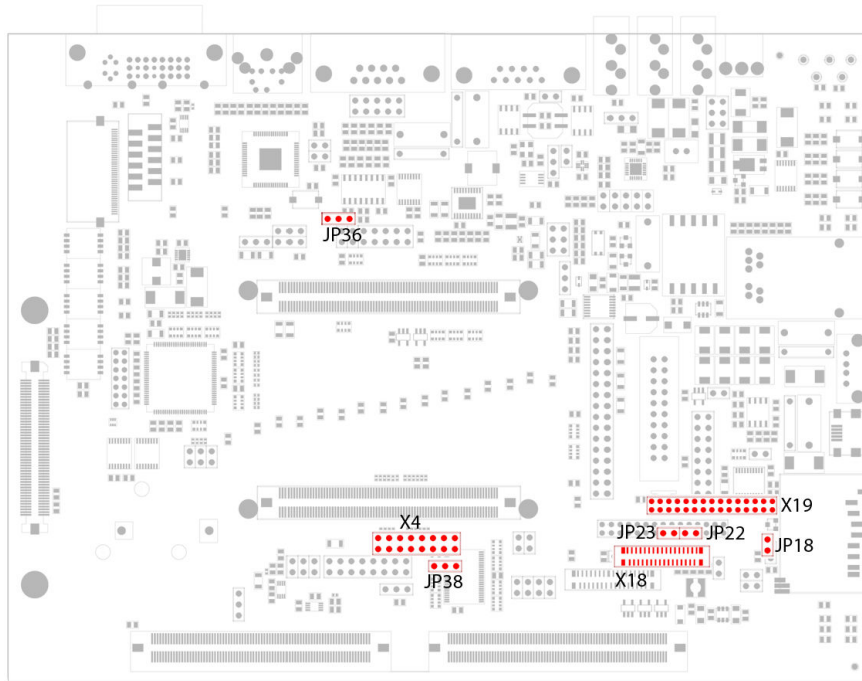
## 31 TV Out



**Fig. 31-1. TV Out Connector**

The TV Out connector (X16) is driven by the Video DAC on the AM3517 processor. This interface supports NTSC, PAL-B,D,G, H, I, and M. The connector is a standard S-Video connector type.

## 32 Camera Interface



**Fig. 32-1. Camera Interface Connectors and Jumpers**

The camera interface is provided to connect a CCD camera. The connectors X19 and X18 are PHYTEC standard connectors which can be used to connect a PHYTEC device. A 16 pin 0.1"/2.54mm spaced header (X4) is also provided to connect a camera or to easily probe camera signals.

**Table 32-1. Camera Interface (X4) Signal Descriptions**

Pin	Signal	I/O	Description
1	CCDC_PCLK	IO	Camera CCD interface clock
2	VCC_IO	-	IO Power (1.8V or 3.3V)
3	CCDC_VD	IO	Camera CCD interface - vertical sync
4	GND	-	Ground
5	CCDC_HD	IO	Camera CCD interface - horizontal sync
6	GND	-	Ground
7	CCDC_WE	I	Camera CCD interface - write enable
8	CCDC_DATA4	I	Camera CCD interface - data 4
9	CCDC_FIELD	I	Camera CCD interface - field ID signal
10	CCDC_DATA3	I	Camera CCD interface - data 3
11	CCDC_DATA7	I	Camera CCD interface - data 7
12	CCDC_DATA2	I	Camera CCD interface - data 2
13	CCDC_DATA6	I	Camera CCD interface - data 6

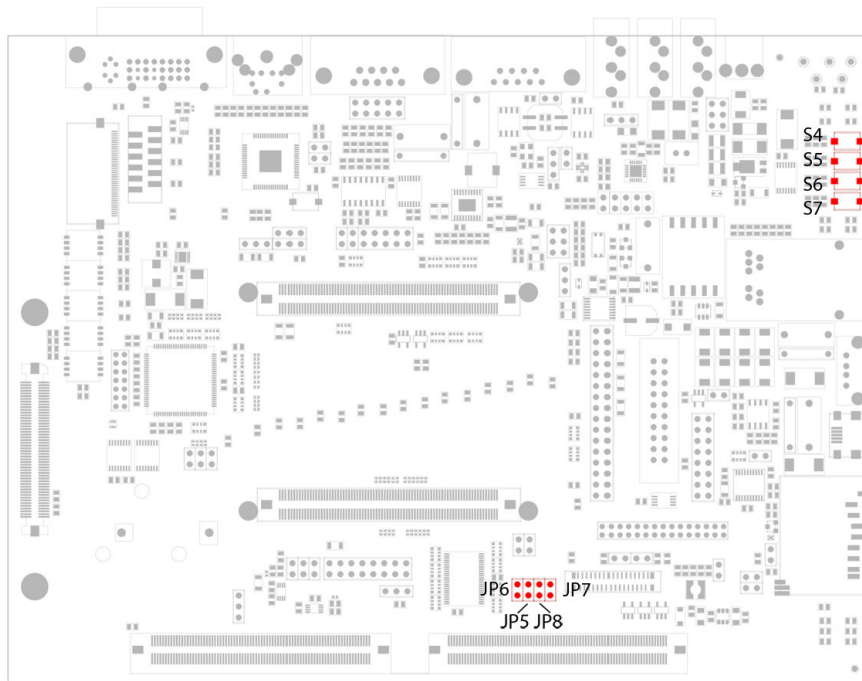
**Table 32-1. Camera Interface (X4) Signal Descriptions**

Pin	Signal	I/O	Description
14	CCDC_DATA1	I	Camera CCD interface - data 1
15	CCDC_DATA5	I	Camera CCD interface - data 5
16	CCDC_DATA0	I	Camera CCD interface - data 0

Below is a detailed list of the connectors and configuration jumpers associated with the camera interface.

- X18** This connector provides the connection point to a PHYTEC supported camera flex cable. See PHYTEC camera offerings for specifics.
- X19** This connector provides a convenient access point to the signals on X18 to aid in debug.
- X4** This connector provides a convenient access point to the AM3517 CCDC signals to aid in debug.
- JP36** This jumper causes the SYS\_CLKOUT2 from the SOM to be connected to nets xSYS\_CLKOUT2A or xSYS\_CLKOUT2B. Install this jumper in the 1+2 setting to connect SYS\_CLKOUT2 to SYSCLKOUT2A net which connects to the Camera section. Install this jumper in the 2+3 setting to connect SYS\_CLKOUT2 to SYSCLKOUT2B net which connects to the Expansion connector.
- JP23** This jumper controls the Camera as described in phyCAM-P manual.
- JP22** This jumper controls the Camera as described in phyCAM-P manual.
- JP38** This jumper is provided to tristate all the outputs of all the Camera interface level translator U13. Install this jumper in the 1+2 setting to allow the AM3517 to control the output enable of U13. Install this jumper in the 2+3 to continuously enable the output from U13. Remove this jumper completely to disable the outputs of U13
- JP18** This jumper is provided to disconnect power from the VCC\_CAM rail.

### 33 User Buttons



**Fig. 33-1. User Buttons and Jumpers**

Four user buttons are provided for development purposes. [Figure 33-1](#) shows the location of the user buttons and associated configuration jumpers. The configuration jumpers allow disconnection of the button outputs from the processor GPIOs signals.

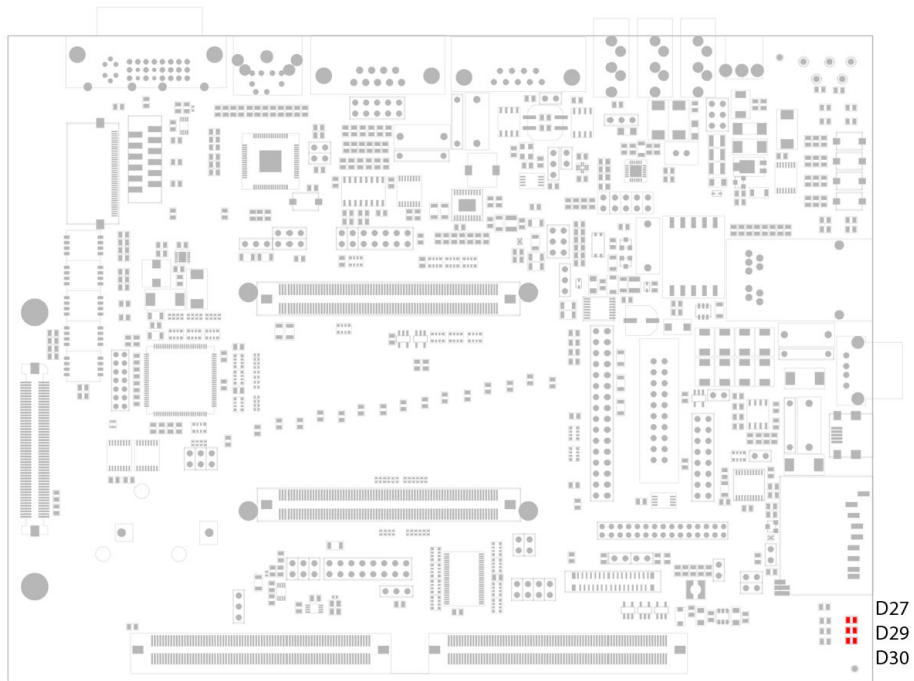
Below is a detailed list of the user buttons and configuration jumpers associated with them.

- S4** User button 1 (BTN1). Pressing this button generates a debounced, active, low signal to the processor. Holding this button will keep the output to ETK\_D10 held low. Releasing this button will keep the output to ETK\_D10 held high.
- S5** User button 2 (BTN2). Pressing this button generates a debounced, active, low signal to the processor. Holding this button will keep the output to ETK\_D11 held low. Releasing this button will keep the output to ETK\_D11 held high.
- S6** User button 3 (BTN3). Pressing this button generates a debounced, active, low signal to the processor. Holding this button will keep the output to ETK\_D12 held low. Releasing this button will keep the output to ETK\_D12 held high.
- S7** User button 4 (BTN4). Pressing this button generates a debounced, active, low signal to the processor. Holding this button will keep the output to ETK\_D13 held low. Releasing this button will keep the output to ETK\_D13 held high.

- JP7** Connects the output of BTN1 (S7) to processor signal ETK\_D10. By default this jumper is CLOSED, connecting BTN1 to ETK\_D10. OPEN this jumper if ETK\_D10 is needed for external use.
- JP5** Connects the output of BTN2 (S6) to processor signal ETK\_D11. By default this jumper is CLOSED, connecting BTN1 to ETK\_D11. OPEN this jumper if ETK\_D11 is needed for external use.
- JP6** Connects the output of BTN3 (S5) to processor signal ETK\_D12. By default this jumper is CLOSED, connecting BTN1 to ETK\_D12. OPEN this jumper if ETK\_D12 is needed for external use.
- JP8** Connects the output of BTN4 (S4) to processor signal ETK\_D13. By default this jumper is CLOSED, connecting BTN1 to ETK\_D13. OPEN this jumper if ETK\_D13 is needed for external use.



## 34 User LEDs



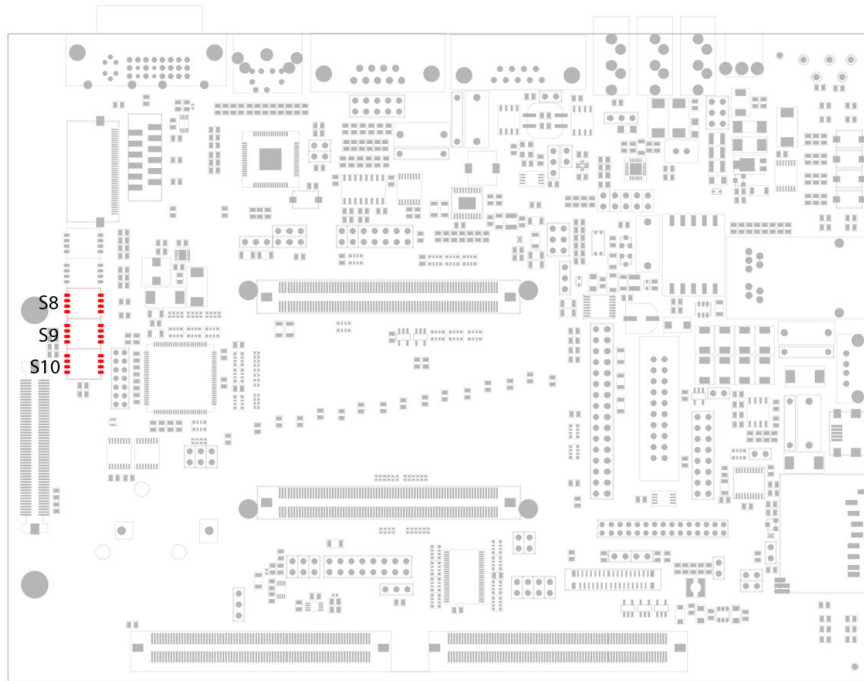
**Fig. 34-1. User LEDs and Jumpers**

Three user LEDs are provided for development purposes. [Figure 34-1](#) shows the location of the User LEDs.

Below is a detailed list of the user LEDs.

- D29** Green User LED 1. Drive processor signal MCBSP4\_CLKX high to turn this LED on and low to turn this LED off.
- D27** Green User LED 2. Drive processor signal MCBSP4\_DR high to turn this LED on and low to turn this LED off.
- D30** Green User LED 3. Drive processor signal MCBSP4\_DX high to turn this LED on and low to turn this LED off.

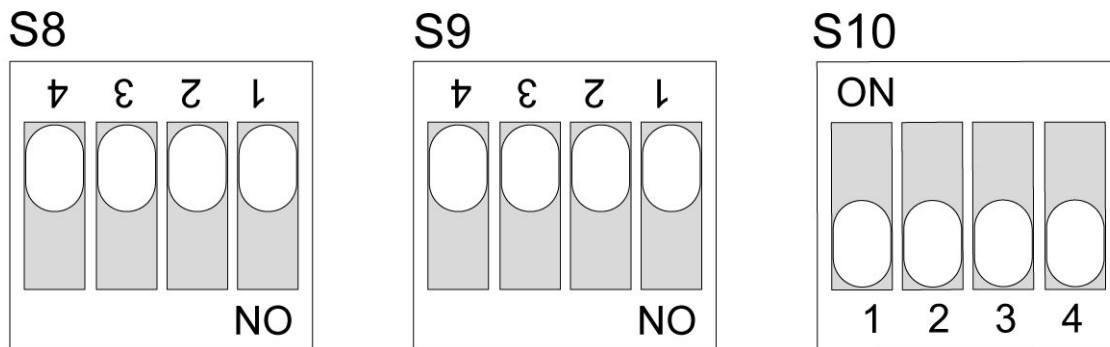
## 35 Boot Mode Selection



**Fig. 35-1. Boot Mode Selection Connectors and Jumpers**

The boot mode switches are provided to configure the boot mode after a reset. By default the boot mode switches are all open, configuring the phyCORE-AM3517 SOM for its default setting of 0b01100 (see AM3517 TRM for definition). In the default mode, the following boot sequence NAND,EMAC,USB,MMC1 is followed by the AM3517. The AM3517 will boot from the first device which has a "valid" image to boot from.

Alternatively S1, S2, and S3 can be set for other boot sequences. Two switches are provided for each SYS\_BOOT signal on the Carrier Board, one to pull the signal high and one to tie it low.



**Fig. 35-2. Boot Switches - Default Settings**

**Table 35-1. Boot Selection Switches and Descriptions**

<b>Switch-Position</b>	<b>Condition</b>	<b>Description</b>
<b>S1-1 / S1-2</b>	<b>Open/Open</b>	<b>SYS_BOOT5 setting determined by SOM default</b>
	Closed/Open	SYS_BOOT5 is pulled high
	Open/Closed	SYS_BOOT5 is held low
	Closed/Closed	SYS_BOOT5 is held low
<b>S1-3 / S1-4</b>	<b>Open/Open</b>	<b>SYS_BOOT4 setting determined by SOM default</b>
	Closed/Open	SYS_BOOT4 is pulled high
	Open/Closed	SYS_BOOT4 is held low
	Closed/Closed	SYS_BOOT4 is held low
<b>S2-1 / S2-2</b>	<b>Open/Open</b>	<b>SYS_BOOT3 setting determined by SOM default</b>
	Closed/Open	SYS_BOOT3 is pulled high
	Open/Closed	SYS_BOOT3 is held low
	Closed/Closed	SYS_BOOT3 is held low
<b>S2-3 / S2-4</b>	<b>Open/Open</b>	<b>SYS_BOOT2 setting determined by SOM default</b>
	Closed/Open	SYS_BOOT2 is pulled high
	Open/Closed	SYS_BOOT2 is held low
	Closed/Closed	SYS_BOOT2 is held low
<b>S3-1 / S3-2</b>	<b>Open/Open</b>	<b>SYS_BOOT1 setting determined by SOM default</b>
	Closed/Open	SYS_BOOT1 is pulled high
	Open/Closed	SYS_BOOT1 is held low
	Closed/Closed	SYS_BOOT1 is held low
<b>S3-3 / S3-4</b>	<b>Open/Open</b>	<b>SYS_BOOT0 setting determined by SOM default</b>
	Closed/Open	SYS_BOOT0 is pulled high
	Open/Closed	SYS_BOOT0 is held low
	Closed/Closed	SYS_BOOT0 is held low

Refer to [Table 35-2](#) for each of the possible boot configurations supported by the phyCORE-AM3517 SOM and Carrier Board switches.

**Table 35-2. Boot Order Switch Configurations**

<b>Boot Order</b>				<b>Switch Configuration</b>		
<b>First</b>	<b>Second</b>	<b>Third</b>	<b>Forth</b>	<b>S8 1-4</b>	<b>S9 1-4</b>	<b>S10 1-4</b>
NAND	EMAC	USB		(off,on,off,on)	(off,on,off,on)	(off,on,on,off)
MMC2	EMAC	USB	MMC1	(off,on,off,on)	(off,on,off,on)	(on,off,on,off)
MMC2	USB			(off,on,off,on)	(off,on,on,off)	(off,on,on,off)
MMC1	USB			(off,on,off,on)	(off,on,on,off)	(on,off,off,on)

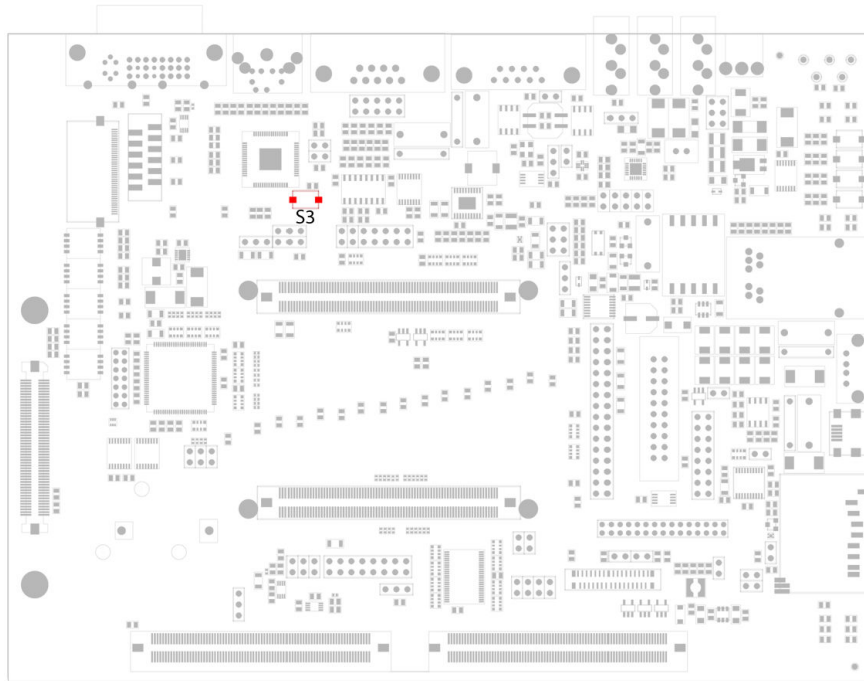
**Table 35-2. Boot Order Switch Configurations**

<b>Boot Order</b>				<b>Switch Configuration</b>		
<b>First</b>	<b>Second</b>	<b>Third</b>	<b>Forth</b>	<b>S8 1-4</b>	<b>S9 1-4</b>	<b>S10 1-4</b>
XIP	EMAC	USB		(off,on,off,on)	(off,on,on,off)	(on,off,on,off)
XDOC	EMAC	USB		(off,on,off,on)	(on,off,off,on)	(off,on,off,on)
MMC2	EMAC	USB		(off,on,off,on)	(on,off,off,on)	(off,on,on,off)
XIP	EMAC	USB	MMC1	(off,on,off,on)	(on,off,off,on)	(on,off,off,on)
XDOC	EMAC	USB	MMC1	(off,on,off,on)	(on,off,off,on)	(on,off,on,off)
NAND	EMAC	USB	MMC1	(off,on,off,on)	(on,off,on,off)	(off,on,off,on)
XIP	USB	UART	MMC1	(off,on,off,on)	(on,off,on,off)	(off,on,on,off)
XDOC	USB	UART	MMC1	(off,on,off,on)	(on,off,on,off)	(on,off,off,on)
NAND	USB	UART	MMC1	(off,on,off,on)	(on,off,on,off)	(on,off,on,off)
MMC2	USB	UART	MMC1	(off,on,on,off)	(off,on,off,on)	(off,on,on,off)
MMC1	USB	UART		(off,on,on,off)	(off,on,off,on)	(on,off,off,on)
XIP	UART			(off,on,on,off)	(off,on,off,on)	(on,off,on,off)
XDOC	UART			(off,on,on,off)	(off,on,on,off)	(off,on,off,on)
NAND	UART			(off,on,on,off)	(off,on,on,off)	(off,on,on,off)
MMC2	UART			(off,on,on,off)	(off,on,on,off)	(on,off,on,off)
MMC1	UART			(off,on,on,off)	(on,off,off,on)	(off,on,off,on)
XIP	USB			(off,on,on,off)	(on,off,off,on)	(off,on,on,off)
XDOC	USB			(off,on,on,off)	(on,off,off,on)	(on,off,off,on)
NAND	USB			(off,on,on,off)	(on,off,off,on)	(on,off,on,off)
SPI	UART			(off,on,on,off)	(on,off,on,off)	(off,on,off,on)
EMAC	USB	NAND		(on,off,off,on)	(off,on,off,on)	(off,on,on,off)
EMAC	USB	MMC1	MMC2	(on,off,off,on)	(off,on,off,on)	(on,off,on,off)
USB	MMC2			(on,off,off,on)	(off,on,on,off)	(off,on,on,off)
USB	MMC1			(on,off,off,on)	(off,on,on,off)	(on,off,off,on)
EMAC	USB	XIP		(on,off,off,on)	(off,on,on,off)	(on,off,on,off)
EMAC	USB	XDOC		(on,off,off,on)	(on,off,off,on)	(off,on,off,on)
EMAC	USB	MMC2		(on,off,off,on)	(on,off,off,on)	(off,on,on,off)
EMAC	USB	MMC1	XIP	(on,off,off,on)	(on,off,off,on)	(on,off,off,on)
EMAC	USB	MMC1	XDOC	(on,off,off,on)	(on,off,off,on)	(on,off,on,off)
EMAC	USB	MMC1	NAND	(on,off,off,on)	(on,off,on,off)	(off,on,off,on)
USB	UART	MMC1	XIP	(on,off,off,on)	(on,off,on,off)	(off,on,on,off)
USB	UART	MMC1	XDOC	(on,off,off,on)	(on,off,on,off)	(on,off,off,on)
USB	UART	MMC1	NAND	(on,off,off,on)	(on,off,on,off)	(on,off,on,off)
USB	UART	MMC1	MMC2	(on,off,on,off)	(off,on,off,on)	(off,on,on,off)
USB	UART	MMC1		(on,off,on,off)	(off,on,off,on)	(on,off,off,on)
UART	XIP			(on,off,on,off)	(off,on,off,on)	(on,off,on,off)

**Table 35-2. Boot Order Switch Configurations**

<b>Boot Order</b>				<b>Switch Configuration</b>		
<b>First</b>	<b>Second</b>	<b>Third</b>	<b>Forth</b>	<b>S8 1-4</b>	<b>S9 1-4</b>	<b>S10 1-4</b>
UART	XDOC			(on,off,on,off)	(off,on,on,off)	(off,on,off,on)
UART	NAND			(on,off,on,off)	(off,on,on,off)	(off,on,on,off)
UART	MMC2			(on,off,on,off)	(off,on,on,off)	(on,off,on,off)
UART	MMC1			(on,off,on,off)	(on,off,off,on)	(off,on,off,on)
USB	XIP			(on,off,on,off)	(on,off,off,on)	(off,on,on,off)
USB	XDOC			(on,off,on,off)	(on,off,off,on)	(on,off,off,on)
USB	NAND			(on,off,on,off)	(on,off,off,on)	(on,off,on,off)
UART	SPI			(on,off,on,off)	(on,off,on,off)	(off,on,off,on)

## 36 System Reset Button



**Fig. 36-1. System Reset Button**

A system reset button is provided to reset the processor and its peripherals. [Figure 36-1](#) shows the position of the reset button on the Carrier Board.

Momentarily pressing button S3 will generate a system reset.

Refer to [Table 35-2](#) for each of the possible boot configurations supported by the phyCORE-AM3517 SOM and Carrier Board switches.

---

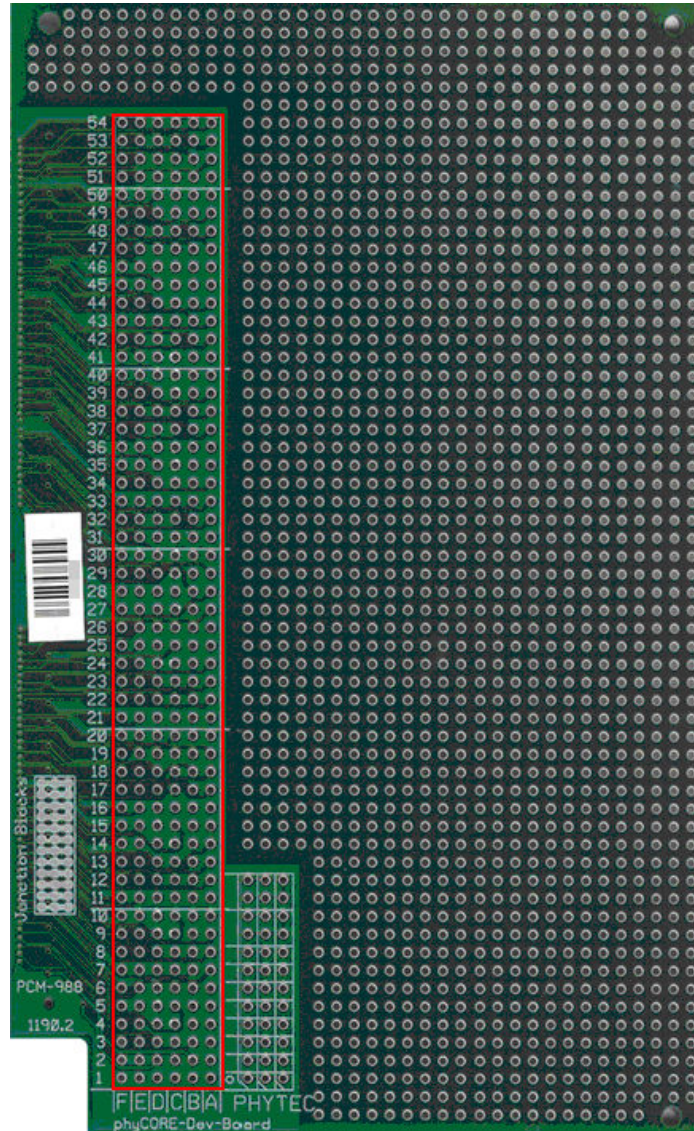
## **Part III: PCM-988/GPIO Expansion Board**

---

Part 3 of this three part manual provides detailed information on the GPIO Expansion Board and how it enables easy access to most phyCORE-AM3517 SOM signals.

The information in the following chapters is applicable to the 1190.2 PCB revision of the GPIO Expansion Board.

## 37 Introduction



**Fig. 37-1. PCM-988/GPIO Expansion Board and Patch Field**

The optional PCM-988/GPIO Expansion Board add-on provides an easy means of accessing the phyCORE-AM3517 SOM signals in addition to Carrier Board generated signals via a 2.54mm/0.1in spaced patch field. The Expansion Board also provides an empty prototyping area for soldering additional test circuits to interface the phyCORE-AM3517 SOM.

The Expansion Board interfaces the SOM and Carrier Board via the Carrier Board expansion bus connector X14. Nearly all signals from the phyCORE-AM3517 extend in a strict 1:1 assignment to the Expansion Bus connector. These signals, in turn, are routed in a similar manner to the patch field on the Expansion Board.

A two-dimensional numbering matrix, similar to the one used for the pin layout of the phyCORE-Connector, is provided to identify signals on the Carrier Board Expansion Bus connector X14 and the Expansion Board patch field. See [Figure 26-1](#) for the pin numbering on the Carrier Board expansion bus connector



X14. See [Figure 37-1](#) for the pin numbering on the Expansion Board patch field ([red box](#)). The patch field pin numbering is composed of a row number and a column letter: e.g. 24C. Patch field rows extend from 1 to 54 while columns extend from A to F.

Select phyCORE-AM3517 signals have been removed from the GPIO expansion connector for signal integrity reasons. [Table 37-1](#) lists the signal groups which have not been routed from the phyCORE-AM3517 Molex connector to the GPIO expansion connector and also provides a reference to where the signals can be located on the Carrier Board.

**Table 37-1. GPIO Expansion Connector - Signals Removed**

Signal Group	Routed To	Chapter
CCDC	X4, X19, X18	<a href="#">32</a>
MMC2	X7	<a href="#">28</a>
TV OUT	X16	<a href="#">31</a>
JTAG	X13	<a href="#">21</a>
ENET	None (highly encoded)	<a href="#">23</a>
MMC1	X3	<a href="#">28</a>
MCBSP2	JP12, JP15, JP16, JP17	<a href="#">28</a>
DSS	Resistor networks at the output of CPLD	<a href="#">25</a>
LVDS LCD	X12 (highly encoded)	<a href="#">25</a>
USB 0 & 1	X1, X2 (highly encoded)	<a href="#">24</a>
MCBSP1	X7	<a href="#">28</a>

The following chapters and tables arranged in functional groups, show the relationship between the phyCORE-AM3517 signal, the location on the GPIO expansion bus connector, and where to find the associated signal on the Expansion Board patch field. Please note that because there are a number of multiplexed pins on the AM3517 processor, a particular pin may fall in multiple groups, and hence will be repeated in several tables.

## 38 System Signal Mapping

Table 38-1 provides signal mapping for the SOM system signals.

The *Signal* column specifies the signal name used on the phyCORE-Connector and throughout the phyCORE-AM3517 schematics. The *SOM* column specifies the pin number on the phyCORE-Connector on the SOM (see [Chapter 2](#)). The *Expansion Bus* column specifies the pin number on the GPIO expansion bus connector (see [Chapter 26](#)) on the Carrier Board. The *Patch Field* column specifies the location of the signal on the GPIO Expansion Board patch field.

**Table 38-1. System Signal Mapping**

Signal	SOM	Expansion Bus	Patch Field
/RESET	8C	8C	3E
xSYS_NRESWARM	9C	9C	3B
xSYS_CLKOUT1	10C	10C	3D
SYS_BOOT6	11C	11C	4E
SYS_BOOT4	13C	13C	4F
SYS_BOOT3	14C	14C	5C
SYS_NIRQ	8D	8D	3A
/RESIN	10D	10D	3F
SYS_CLKREQ	11D	11D	4A
xSYS_CLKOUT2	12D	12D	12D
SYS_BOOT5	13D	13D	13D
SYS_BOOT2	15D	15D	5B
SYS_BOOT1	16D	16D	6A
SYS_BOOT0	17D	17D	6C

### 39 GPMC Signal Mapping

Table 39-1 provides signal mapping for the SOM memory bus signals for connection of external memory mapped devices.

The *Signal* column specifies the signal name used on the phyCORE-Connector and throughout the phyCORE-AM3517 schematics. The *SOM* column specifies the pin number on the phyCORE-Connector on the SOM (see Chapter 2). The *Expansion Bus* column specifies the pin number on the GPIO expansion bus connector (see Chapter 26) on the Carrier Board. The *Patch Field* column specifies the location of the signal on the GPIO Expansion Board patch field.

**Table 39-1. GPMC Signal Mapping**

Signal	SOM	Expansion Bus	Patch Field
GPMC_NCS7	1A	1A	28A
GPMC_NCS3	3A	3A	28B
GPMC_NCS2	4A	4A	29A
GPMC_NCS1	5A	5A	29E
GPMC_NWE	6A	6A	29D
GPMC_NBE0_CLE	8A	8A	30E
GPMC_NBE1	9A	9A	30D
GPMC_WAIT0	10A	10A	30F
GPMC_WAIT2	11A	11A	31E
GPMC_A9	13A	13A	32A
GPMC_A8	14A	14A	32E
GPMC_A7	15A	15A	32B
GPMC_A4	16A	16A	33A
GPMC_A1	18A	18A	33B
GPMC_D15	19A	19A	34B
GPMC_D14	20A	20A	34E
GPMC_D11	21A	21A	34D
GPMC_D8	23A	23A	35E
GPMC_D7	24A	24A	35D
GPMC_D6	25A	25A	35F
GPMC_D3	26A	26A	36E
GPMC_D0	28A	28A	37A
GPMC_NCS6	1B	1B	28C
GPMC_NCS5	2B	2B	28E
GPMC_NCS4	3B	3B	28F
GPMC_NWP	6B	6B	29F
GPMC_NOE	7B	7B	30A
xGPMC_NADV_ALE	8B	8B	30B
GPMC_WAIT1	10B	10B	31A

**Table 39-1. GPMC Signal Mapping**

<b>Signal</b>	<b>SOM</b>	<b>Expansion Bus</b>	<b>Patch Field</b>
GPMC_WAIT3	11B	11B	31B
xGPMC_CLK	12B	12B	31F
GPMC_A10	13B	13B	32C
GPMC_A6	15B	15B	32F
GPMC_A5	16B	16B	33C
GPMC_A3	17B	17B	33E
GPMC_A2	18B	18B	33F
GPMC_D13	20B	20B	34B
GPMC_D12	21B	21B	34F
GPMC_D10	22B	22B	35A
GPMC_D9	23B	23B	35B
GPMC_D5	25B	25B	36A
GPMC_D4	26B	26B	36B
GPMC_D2	27B	27B	36F
GPMC_D1	28B	28B	37C

## 40 UART Signal Mapping

Table 40-1 provides signal mapping for the SOM UART signals. All signals that end in “RS232” are at RS-232 levels. All signals that do not end in “RS232” are at TTL levels.

The *Signal* column specifies the signal name used on the phyCORE-Connector and throughout the phyCORE-AM3517 schematics. The *SOM* column specifies the pin number on the phyCORE-Connector on the SOM (see Chapter 2). The *Expansion Bus* column specifies the pin number on the GPIO expansion bus connector (see Chapter 26) on the Carrier Board. The *Patch Field* column specifies the location of the signal on the GPIO Expansion Board patch field.

**Table 40-1. UART Signal Mapping**

Signal	SOM	Expansion Bus	Patch Field
UART1_RTS	63B	63B	48F
UART1_CTS	65B	65B	49B
UART1_RX	15C	15C	5E
UART1_TX	16C	16C	5F
UART3_TX_RS232	40C	40C	13D
UART3_RX_RS232	41C	41C	14A
UART2_CTS	43C	43C	14F
UART2_RTS	44C	44C	15C
UART2_TX	45C	45C	15E
UART2_RX	46C	46C	15F

## 41 I<sup>2</sup>C Signal Mapping

Table 41-1 provides signal mapping for the SOM I<sup>2</sup>C signals.

The *Signal* column specifies the signal name used on the phyCORE-Connector and throughout the phyCORE-AM3517 schematics. The *SOM* column specifies the pin number on the phyCORE-Connector on the SOM (see [Chapter 2](#)). The *Expansion Bus* column specifies the pin number on the GPIO expansion bus connector (see [Chapter 26](#)) on the Carrier Board. The *Patch Field* column specifies the location of the signal on the GPIO Expansion Board patch field.

**Table 41-1. I<sup>2</sup>C Signal Mapping**

<b>Signal</b>	<b>SOM</b>	<b>Expansion Bus</b>	<b>Patch Field</b>
I2C2_SDA	50C	50C	17A
I2C2_SCL	51C	51C	17B
I2C1_SDA	53C	53C	18A
I2C1_SCL	54C	54C	18B
I2C3_SCL	61B	61B	48C
I2C3_SDA	62B	62B	48E

## 42 GPIO Signal Mapping

Table 42-1 provides signal mapping for the SOM GPI, GPO, and GPIO signals.

The *Signal* column specifies the signal name used on the phyCORE-Connector and throughout the phyCORE-AM3517 schematics. The *SOM* column specifies the pin number on the phyCORE-Connector on the SOM (see [Chapter 2](#)). The *Expansion Bus* column specifies the pin number on the GPIO expansion bus connector (see [Chapter 26](#)) on the Carrier Board. The *Patch Field* column specifies the location of the signal on the GPIO Expansion Board patch field.

**Table 42-1. GPIO Signal Mapping**

<b>Signal</b>	<b>SOM</b>	<b>Expansion Bus</b>	<b>Patch Field</b>
ETK_D15	43A	43A	42A
ETK_D14	44A	44A	42E
ETK_D13	45A	45A	42B
ETK_D10	46A	46A	43A
ETK_D12	45B	45B	42F
ETK_D11	46B	46B	43C

## 43 USB Signal Mapping

Table 43-1 provides signal mapping for the SOM USB signals.

The *Signal* column specifies the signal name used on the phyCORE-Connector and throughout the phyCORE-AM3517 schematics. The *SOM* column specifies the pin number on the phyCORE-Connector on the SOM (see Chapter 2). The *Expansion Bus* column specifies the pin number on the GPIO expansion bus connector (see Chapter 26) on the Carrier Board. The *Patch Field* column specifies the location of the signal on the GPIO Expansion Board patch field.

**Table 43-1. USB Signal Mapping**

<b>Signal</b>	<b>SOM</b>	<b>Expansion Bus</b>	<b>Patch Field</b>
HSUSB1_DATA3	48A	48A	43B
HSUSB1_DATA6	49A	49A	44A
HSUSB1_DATA5	50A	50A	44E
HSUSB1_DATA2	51A	51A	44D
HSUSB1_STP	53A	53A	45E
xHSUSB1_CLK	54A	54A	45D
HSUSB1_NXT	47B	47B	43E
HSUSB1_DIR	48B	48B	43F
HSUSB1_DATA4	50B	50B	44B
HSUSB1_DATA7	51B	51B	44F
HSUSB1_DATA1	52B	52B	45A
HSUSB1_DATA0	53B	53B	45B



## 44 CAN Signal Mapping

Table 44-1 provides signal mapping for the SOM CAN signals.

The *Signal* column specifies the signal name used on the phyCORE-Connector and throughout the phyCORE-AM3517 schematics. The *SOM* column specifies the pin number on the phyCORE-Connector on the SOM (see [Chapter 2](#)). The *Expansion Bus* column specifies the pin number on the GPIO expansion bus connector (see [Chapter 26](#)) on the Carrier Board. The *Patch Field* column specifies the location of the signal on the GPIO Expansion Board patch field.

**Table 44-1. CAN Signal Mapping**

<b>Signal</b>	<b>SOM</b>	<b>Expansion Bus</b>	<b>Patch Field</b>
HECC1_TXD	48C	48C	16E
HECC1_RXD	49C	49C	16F

## 45 Ethernet Signal Mapping

Table 45-1 provides signal mapping for the SOM Ethernet signals.

The *Signal* column specifies the signal name used on the phyCORE-Connector and throughout the phyCORE-AM3517 schematics. The *SOM* column specifies the pin number on the phyCORE-Connector on the SOM (see Chapter 2). The *Expansion Bus* column specifies the pin number on the GPIO expansion bus connector (see Chapter 26) on the Carrier Board. The *Patch Field* column specifies the location of the signal on the GPIO Expansion Board patch field.

**Table 45-1. Ethernet Signal Mapping**

Signal	SOM	Expansion Bus	Patch Field
RMII_MDIO_CLK	38A	38A	40E
RMII_MDIO_DATA	39A	39A	40D
RMII_RXD1	40A	40A	40F
RMII_RXER	41A	41A	41E
RMII_50MHZ_CLK	37B	37B	40A
RMII_CRS_DV	38B	38B	40B
RMII_RXD0	40B	40B	41A
RMII_TXD1	41B	41B	41B
RMII_TXD0	42B	42B	41F
RMII_TXEN	43B	43B	42C

## 46 HDQ Signal Mapping

Table 46-1 provides signal mapping for the SOM HDQ/1-wire signals.

The *Signal* column specifies the signal name used on the phyCORE-Connector and throughout the phyCORE-AM3517 schematics. The *SOM* column specifies the pin number on the phyCORE-Connector on the SOM (see [Chapter 2](#)). The *Expansion Bus* column specifies the pin number on the GPIO expansion bus connector (see [Chapter 26](#)) on the Carrier Board. The *Patch Field* column specifies the location of the signal on the GPIO Expansion Board patch field.

**Table 46-1.** HDQ Signal Mapping

<b>Signal</b>	<b>SOM</b>	<b>Expansion Bus</b>	<b>Patch Field</b>
HDQ_SIO	18D	18D	6B

## 47 McBSP Signal Mapping

Table 47-1 provides signal mapping for the SOM McBSP (Multichannel Buffered Serial Port) signals.

The *Signal* column specifies the signal name used on the phyCORE-Connector and throughout the phyCORE-AM3517 schematics. The *SOM* column specifies the pin number on the phyCORE-Connector on the SOM (see Chapter 2). The *Expansion Bus* column specifies the pin number on the GPIO expansion bus connector (see Chapter 26) on the Carrier Board. The *Patch Field* column specifies the location of the signal on the GPIO Expansion Board patch field.

**Table 47-1. McBSP Signal Mapping**

<b>Signal</b>	<b>SOM</b>	<b>Expansion Bus</b>	<b>Patch Field</b>
MCBSP1_FSR	36C	36C	12B
MCBSP1_CLKR	38C	38C	13A
MCBSP_CLKS	39C	39C	13B
MCBSP3_CLKX	70B	70B	51A
MCBSP3_DR	71B	71B	51B
MCBSP3_DX	72B	72B	51F
MCBSP3_FSX	73B	73B	52C
MCBSP4_CLKX	70A	70A	50F
MCBSP4_DR	71A	71A	51E
MCBSP4_DX	73A	73A	52A
MCBSP4_FSX	74A	74A	52E

## 48 SPI Signal Mapping

Table 48-1 provides signal mapping for the SOM SPI signals.

The *Signal* column specifies the signal name used on the phyCORE-Connector and throughout the phyCORE-AM3517 schematics. The *SOM* column specifies the pin number on the phyCORE-Connector on the SOM (see Chapter 2). The *Expansion Bus* column specifies the pin number on the GPIO expansion bus connector (see Chapter 26) on the Carrier Board. The *Patch Field* column specifies the location of the signal on the GPIO Expansion Board patch field.

**Table 48-1. SPI Signal Mapping**

Signal	SOM	Expansion Bus	Patch Field
MCSP11_SIMO	30D	30D	10B
MCSP11_CS1	31D	31D	11A
MCSP11_CS0	32D	32D	11C
xMCSP11_CLK	28C	28C	9F
MCSP11_SOMI	29C	29C	10C
MCSP11_CS3	30C	30C	10E
MCSP11_CS2	31C	31C	10F
MCSP12_CS1	61A	61A	48A
MCSP12_CS0	63A	63A	48B
MCSP12_SIMO	64A	64A	49A
MCSP12_SOMI	65A	65A	49E
xMCSP12_CLK	66A	66A	49D

## 49 Power Signal Mapping

Table 49-1 provides signal mapping for the SOM power signals.

The *Signal* column specifies the signal name used on the phyCORE-Connector and throughout the phyCORE-AM3517 schematics. The *SOM* column specifies the pin number on the phyCORE-Connector on the SOM (see Chapter 2). The *Expansion Bus* column specifies the pin number on the GPIO expansion bus connector (see Chapter 26) on the Carrier Board. The *Patch Field* column specifies the location of the signal on the GPIO Expansion Board patch field.

**Table 49-1. Power Signal Mapping**

Signal	SOM	Expansion Bus	Patch Field
VIN	1D	1D	1A, 2C
VIN	2D	2D	1A, 2C
VCC_1V8	4D	4D	2C, 1D
VCC_1V8	5D	5D	2C, 1D
VDDSHV	6D	6D	2D
VDDSHV	7D	7D	2F
GND	2A, 7A, 12A, 17A, 22A, 27A, 32A, 37A, 42A, 47A, 52A, 57A, 62A, 67A, 72A, 77A, 4B, 9B, 14B, 19B, 24B, 29B, 34B, 39B, 44B, 49B, 54B, 59B, 64B, 69B, 74B, 79B, 7C, 12C, 17C, 22C, 27C, 32C, 37C, 42C, 47C, 52C, 57C, 62C, 67C, 72C, 77C, 3D, 9D, 14D, 19D, 24D, 29D, 34D, 39D, 44D, 49D, 54D, 59D, 64D, 9D, 74D, 79D	2A, 7A, 12A, 17A, 22A, 27A, 32A, 37A, 42A, 47A, 52A, 57A, 62A, 67A, 72A, 77A, 4B, 9B, 14B, 19B, 24B, 29B, 34B, 39B, 44B, 49B, 54B, 59B, 64B, 69B, 74B, 79B, 7C, 12C, 17C, 22C, 27C, 32C, 37C, 42C, 47C, 52C, 57C, 62C, 67C, 72C, 77C, 3D, 9D, 14D, 19D, 24D, 29D, 34D, 39D, 44D, 49D, 54D, 59D, 64D, 9D, 74D, 79D	3C, 4C, 7C, 8C, 9C, 12C, 13C, 14C, 17C, 18C, 19C, 22C, 23C, 24C, 27C, 29C, 30C, 31C, 34C, 35C, 36C, 39C, 40C, 41C, 44C, 45C, 46C, 48C, 49C, 50C, 51C, 54C, 4D, 5D, 6D, 9D, 10D, 11D, 14D, 15D, 16D, 19D, 20D, 21D, 24D, 25D, 26D, 28D, 31D, 32D, 33D, 36D, 37D, 38D, 41D, 42D, 43D, 46D, 47D, 48D, 51D, 52D, 54D

## Revision History

**Table 50-1.** Revision History

<b>Date</b>	<b>Version Number</b>	<b>Changes in this Manual</b>
06/06/11	L-761e_1	Preliminary release